



COOLING CARE



AUTOMATIC CLEANING, DIAGNOSTIC
AND CONSERVATION OF COOLING CHANNELS



COOLINGCARE MACHINE - INTRODUCTION

A successful moulding operation requires the efficient use of its equipment. Quality, cycle time and up-time measured by O.E.E (Overall Equipment Effectiveness) indicates the percentage of manufacturing time that is truly productive. The cooling portion of the molding cycle is typically 50% of the molding cycle making it one of the most important areas to be managed.

To reduce cooling cycle times the mold designer incorporates cooling channels which are often complemented with 3D additive conformal cooling inserts. The result is often a significant reduction in overall molding cycle time with the corresponding savings in costs versus conventional cooling.

Today's challenge is maintaining this performance over the lifetime of the tool.

Overtime the cooling channels become restricted with scale and corrosion build up and can even become completely clogged. The result negatively impacts O.E.E. as cycle times become longer and scrap rates increase. Even with operator adjustments the cooling loss cannot be overcome.

The new CoolingCare advanced channel cleaning equipment with Industry 4.0 capabilities is the solution to return the O.E.E. to its original performance levels. Patented technology combines a chemical and mechanical action to free and dissolve the unwanted material. The control panel automates the entire process supporting autonomous cleaning without the need of supervision. A simple text message notifies the operators when the process is complete.



IDENTIFY THE PROBLEM

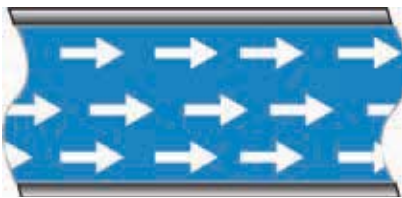

Unrestricted flow of coolant



Partially Restricted flow of coolant

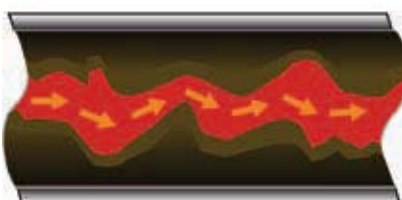

Broadly Restricted flow of coolant

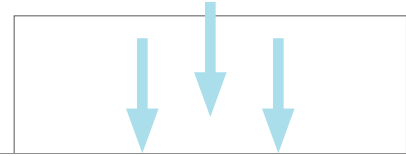

RESTRICTED CHANNEL DIAMETER

FLOW RATE
DETEORINATION

LOWER HEAT
REMOVAL
CAPACITY



COOLING EFFICIENCY DROP

INCREASE
CYCLE TIME

HIGHER MOULD
MAINTENANCE /
REPAIR COST



PROFIT LOSS

CONSTRICTED COOLING CHANNELS

COMPREHENSIVE MAINTENANCE OF COOLING CHANNELS

Capacity to absorb heat is directly proportional to heat conductivity of surfaces taking away the heat.

MATERIAL	Calcium carbonate scale	Calcium sulphate scale	Calcium silicate scale	1.2343 steel
HEAT CONDUCTIVITY W/mK	0,6 - 6	2,3	0,3	24

Due to their low heat conductivity, presence of scale and corrosion products can greatly affect mold cooling efficiency and cause:

- *Drop in production (longer cycle times and scrap rate increase)*
- *Dimensional issues with parts coming from different cavities*
- *Adjustment and correction of injection parameters with every production launch*

INFLUENCE OF LIME DEPOSITION ON COOLING TIME

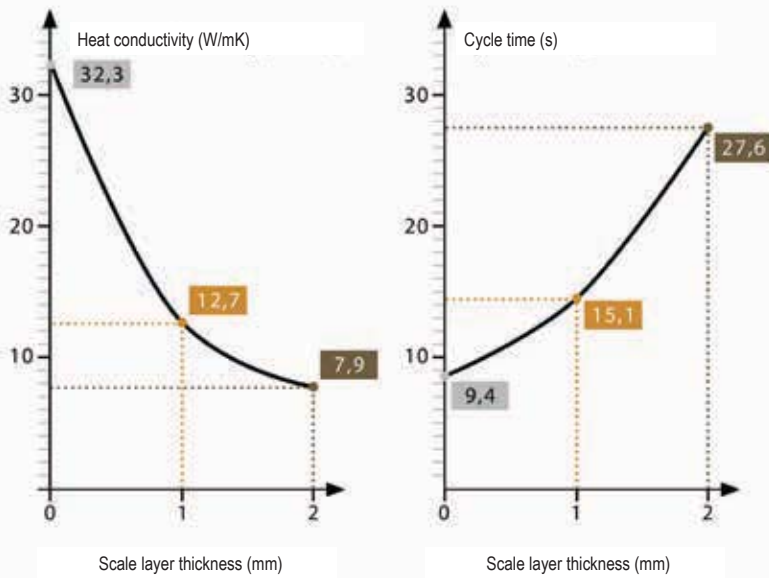

Scale formation depends primarily on water hardness and rises substantially in temperatures above 60°C. Areas with little or zero flow rates are more prone to scale deposition and corrosion issues.

CLEANING MEDIA TYPE IS ADJUSTED TO THE SCALE TYPE

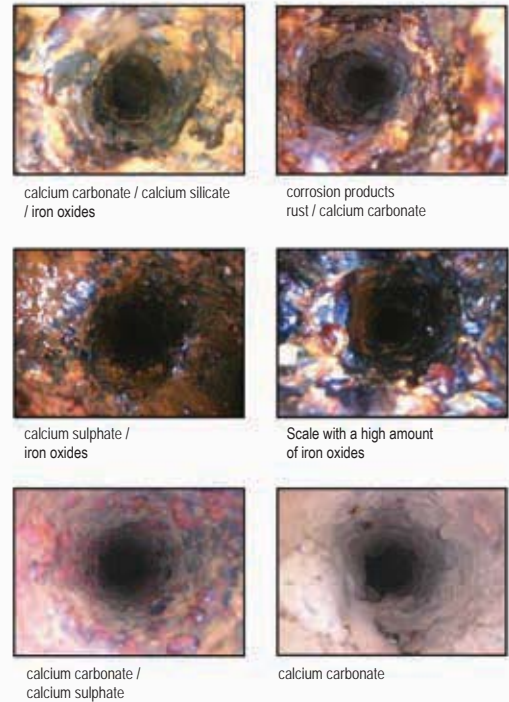

THERMOVISION PICTURE OF A MOLD WITH A CLOGGED COOLING CHANNEL

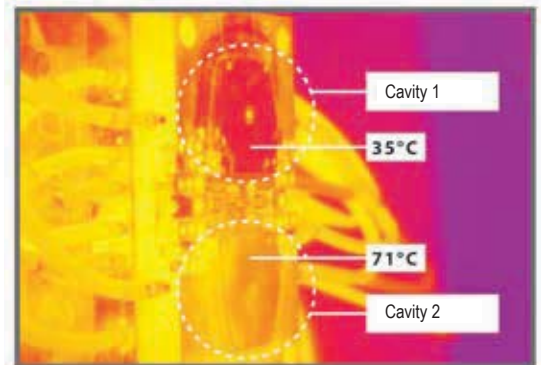

- *Temperature rise in the second cavity*
- *Unstable injection molding conditions*

**CA SERIES - AUTOMATIC CLEANING, DIAGNOSTICS & CONSERVATION OF COOLING CHANNELS
AVAILABLE IN SIX AND TWO CIRCUIT VERSIONS**

- *User friendly interface*
- *10" touchscreen user interface*
- *Fully Automatic - operators are only required to connect the mold and define the channels to be cleaned*
- *A unique design allowing for independent and efficient cleaning of channels regardless of their length and diameter*
- *Advanced archiving system supporting the correct mold maintenance throughout the entire mold operation time*
- *High pulsation dynamics of cleaning allows for less aggressive cleaning media, safe for steel, aluminum, copper and bronze*
- *Intelligent monitoring of the cleaning process - the device recognizes when the desired flow rate values are reached and finishes cleaning*



CA-2 AND CA-6 SERIES FUNCTIONS

Multiple functions allow comprehensive maintenance of cooling channels

1. TIGHTNESS TEST	2. PATENCY TEST
Channel tightness verification before and after cleaning	Detection of clogged channels linked to unclogging function
3. DIAGNOSTICS	4. CLEANING
Flow rate measurement of every channel, comparison of the result with the archived data	Patent pending channel cleaning process based on two-way pulsating movement of cleaning medium
5. NEUTRALIZATION & CONSERVATION	6. REPORTING
Protection of channels with corrosion inhibitors at the end of the rinsing process	Record of all process parameters in the database, export of cleaning reports to external devices



OPTIONAL COMPLIANCE WITH INDUSTRY 4.0

FEATURING: SELF-OPTIMIZATION, INTELLIGENT SERVICE AND COOLINGCARE CONNECT

A trifecta of cutting edge features positions CoolingCare as a leader for Industry 4.0

CoolingCare features cutting edge functions for comprehensive all-in-one maintenance of cooling channels.

Self-Optimization: An advanced monitoring feature enables the machine to clean until a pre-defined flow rate is obtained or the flow rate becomes consistent. This intelligent feature drives efficiency by adjusting the cleaning cycle accordingly. The ultimate results are maximum cleaning efficiency, and reduced labour costs.

Intelligent Service: uses a built in modem for on-line diagnostics and service. This allows for remote diagnostics of machine malfunction by a service technician. Such a feature reduces and may prevent downtime for machine service related issues.



BUILT-IN MODEM



CoolingCare Connect allows an operator to communicate with the machine via text messages (SMS). The machine will send a message to the phone of the defined user alerting them of an alarm (up to 17 alarms can be triggered) for unexpected events such as a failed pressure or blockage test, as well as process completion notifications for lights out cleaning. The operator can also send a test message "S" to the machine requesting its current status. The machine will automatically reply via text message informing the operator of its current mode/action. This feature requires a GSM card (user provided) to be placed in the modem of the machine for wireless external communications.



The CoolingCare Connect machine's database allows for the export of cleaning reports to external devices by means of a USB. CoolingCare Connect technology protects your investments, improves profitability, and provides a low maintenance solution to the high maintenance challenges surrounding cooling channels.

CASE STUDY: TOBACCO HOLDER BASE

- Two-cavity mould
- Moulding inserts - 1.2709 maraging steel (conformal cooling)

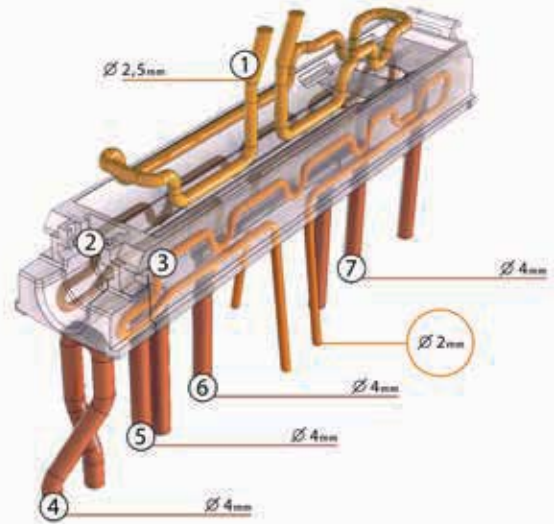

THERMOVISION ANALYSIS OF PARTS IN PRODUCTION CYCLE AFTER 1 YEAR OF PRODUCTION

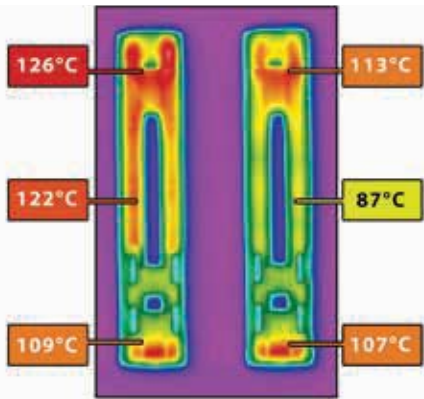

PART TEMPERATURE MEASUREMENT AFTER CLEANING OF CHANNELS

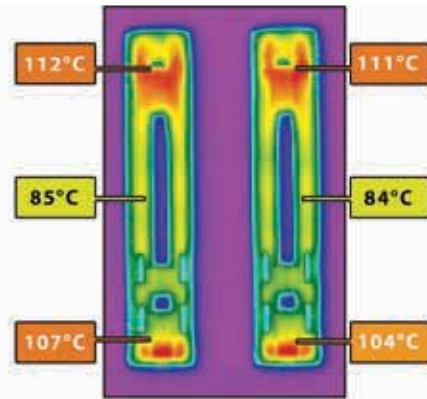

Flow rate loss on one of the cooling channels lead to part temperature increase and deformation. In order to obtain required part dimensional tolerances it was necessary to increase cycle time from 18 to 26 seconds.

FLOW RATE VALUES BEFORE AND AFTER FOUR HOURS OF CLEANING WITH COOLINGCARE CA-6*

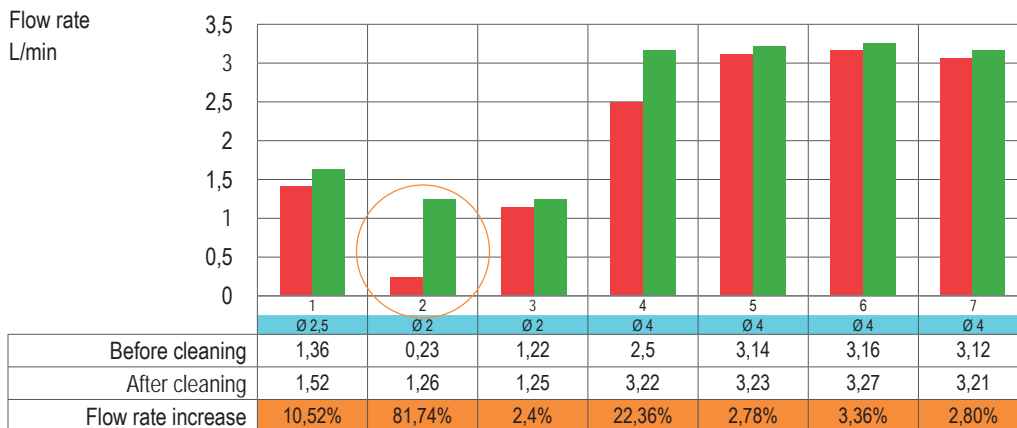

* Measured with CoolingCare CA-6 diagnostics module

CASE STUDY: ROLLER MOTOR HOUSING

- Two-cavity mould
- Moulding inserts - 1.2343 tool steel
- Injection molded material - PS HIPS

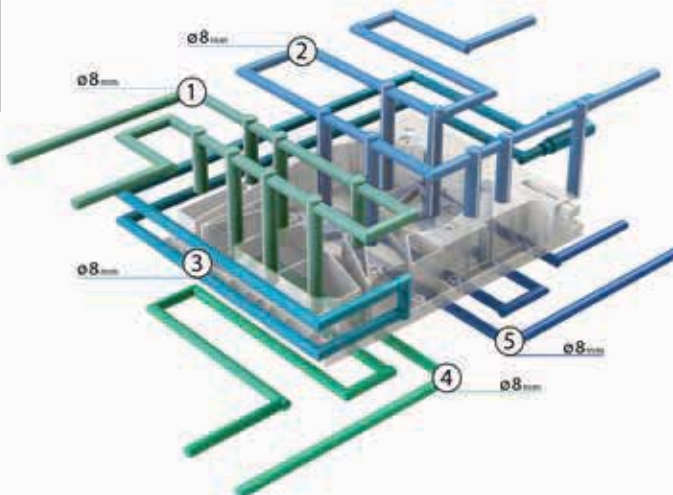

THERMOVISION ANALYSIS OF PARTS IN PRODUCTION CYCLE AFTER 1 YEAR OF PRODUCTION

PART TEMPERATURE MEASUREMENT AFTER CLEANING OF CHANNELS

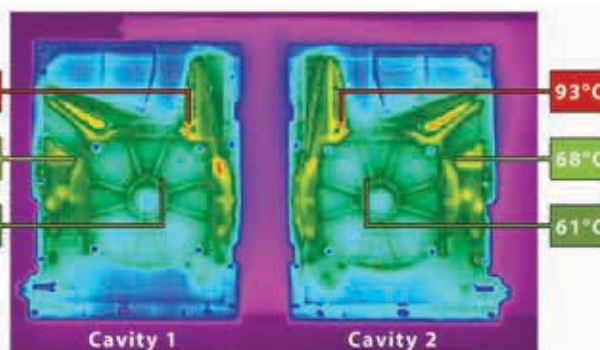
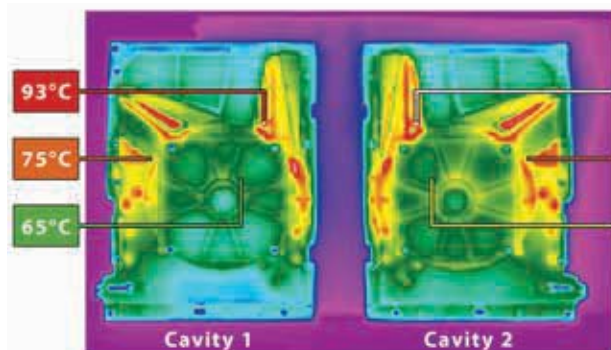

Scale agglomeration inside cooling channels led to part temperature increase and drop in cooling efficiency, negatively affecting cycle time (increase from 43 to 47 seconds).

After 6 hours of channels cleaning part temperature in the same measurement points for unchanged process parameters has been reduced, which enabled return to 43 second cycle time.

FLOW RATE VALUES BEFORE AND AFTER FIVE HOURS OF CLEANING WITH COOLINGCARE CA-6*

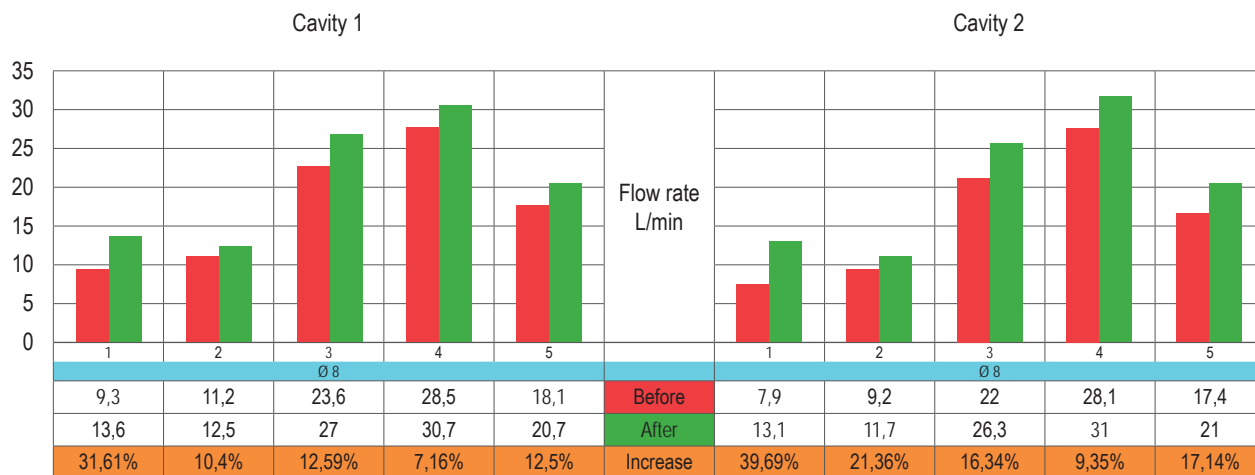

* Measured with CoolingCare CA-6 diagnostics module

CA-2

REF	Description
CLC-CA-2-EU-2	CA-2 COOLINGCARE MACHINE 2 CIRCUITS 2KW
CLC-CA-2-EU-2P	CA-2 COOLINGCARE MACHINE 2 CIRCUITS 2KW INCLUDING CAPACITY PROBE
CLC-CA-2-EU-6	CA-2 COOLINGCARE MACHINE 2 CIRCUITS 6KW
CLC-CA-2-EU-6P	CA-2 COOLINGCARE MACHINE 2 CIRCUITS 6KW INCLUDING CAPACITY PROBE

CLC-K2-R14 KIT FOR 2 CHANNELS FOR 1/4" NIPPLE

Quantity	REF	Description
4	ST17G3/4R3/8	Adapter for CoolingCare machine, machine side
4	PCS938A	Plug from adapter to coupling, machine side, with valve
4	SVK111	Coupling machine side, with valve
8	US17003	Hose clamp
2	801-8RED	Red Hose 1 /2"
2	801-8BLUE	Blue Hose 1 /2"
4	SVK111	Coupling mold side, with valve
4	PCS914A	Plug mold side, with valve

CLC-K2-R38 KIT FOR 2 CHANNELS FOR 3/8" NIPPLE

Quantity	REF	Description
4	ST17G3/4R3/8	Adapter for CoolingCare machine, machine side
4	PCS938A	Plug from adapter to coupling, machine side, with valve
4	SVK111	Coupling machine side, with valve
8	US17003	Hose clamp
2	801-8RED	Red Hose 1 /2"
2	801-8BLUE	Blue Hose 1 /2"
4	SKV111	Coupling mold side, with valve
4	PCS938A	Plug mold side, with valve

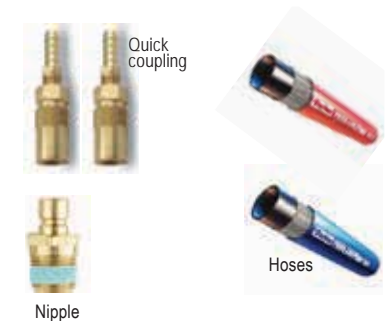
CLC-K2-R12 FOR 2 CHANNELS FOR 1/2" NIPPLE

Quantity	REF	Description
4	ST17G3/4R1/2	Adapter for CoolingCare machine, machine side
4	PCS1612A	Plug from adapter to coupling, machine side, with valve
4	SVK119	Coupling machine side, with valve
8	US17003	Hose clamp
2	801-12RED	Red Hose 3 /4"
2	801-12BLUE	Blue Hose 3 /4"
4	SVK119	Coupling mold side, with valve
4	PCS1612A	Plug mold side, with valve



REF	Description
CLC-40-DS1	Cleaning Media, 10kg (22lbs), suitable for sediment/scale with high concentration of iron oxide, includes corrosion inhibitors
CLC-40-DS2	Cleaning Media, 10kg (22lbs), suitable for sediment/scale with high concentration of calcium carbonate, includes corrosion inhibitors
CNC-30-HTR2KW	CoolingCare Additional Heating Power +2kW, add on kit
CNC-30-MLCP	CoolingCare Cleaning Media Level Probe, add on kit

CA-6

REF	Description
CLC-CA-6-EU-2	CA-6 COOLINGCARE MACHINE 6 CIRCUITS 2KW
CLC-CA-6-EU-2P	CA-6 COOLINGCARE MACHINE 6 CIRCUITS 2KW INCLUDING CAPACITY PROBE
CLC-CA-6-EU-6	CA-6 COOLINGCARE MACHINE 6 CIRCUITS 6KW
CLC-CA-6-EU-6P	CA-6 COOLINGCARE MACHINE 6 CIRCUITS 6KW INCLUDING CAPACITY PROBE



CLC-K2-R14 KIT FOR 6 CHANNELS FOR 1/4" NIPPLE

Quantity	REF	Description
12	ST17G3/4R3/8	Adapter for CoolingCare machine, machine side
12	PCS938A	Plug from adapter to coupling, machine side, with valve
12	SVK111	Coupling machine side, with valve
24	US17003	Hose clamp
6	801-8RED	Red Hose 1 /2"
6	801-8BLUE	Blue Hose 1 /2"
12	SVK111	Coupling mold side, with valve
12	PCS914A	Plug mold side, with valve



CLC-K2-R38 KIT FOR 6 CHANNELS FOR 3/8" NIPPLE

Quantity	REF	Description
12	ST17G3/4R3/8	Adapter for CoolingCare machine, machine side
12	PCS938A	Plug from adapter to coupling, machine side, with valve
12	SVK111	Coupling machine side, with valve
24	US17003	Hose clamp
6	801-8RED	Red Hose 1 /2"
6	801-8BLUE	Blue Hose 1 /2"
12	SKV111	Coupling mold side, with valve
12	PCS938A	Plug mold side, with valve



CLC-K2-R12 FOR 2 CHANNELS FOR 1/2" NIPPLE

Quantity	REF	Description
12	ST17G3/4R1/2	Adapter for CoolingCare machine, machine side
12	PCS1612A	Plug from adapter to coupling, machine side, with valve
12	SVK119	Coupling machine side, with valve
24	US17003	Hose clamp
6	801-12RED	Red Hose 3 /4"
6	801-12BLUE	Blue Hose 3 /4"
12	SVK119	Coupling mold side, with valve
12	PCS1612A	Plug mold side, with valve



REF	Description
CLC-40-DS1	Cleaning Media, 10kg (22lbs), suitable for sediment/scale with high concentration of iron oxide, includes corrosion inhibitors
CLC-40-DS2	Cleaning Media, 10kg (22lbs), suitable for sediment/scale with high concentration of calcium carbonate, includes corrosion inhibitors
CNC-30-HTR2KW	CoolingCare Additional Heating Power +2kW, add on kit
CNC-30-MLCP	CoolingCare Cleaning Media Level Probe, add on kit

CLEANING MEDIA, HEATERS & LEAK DETECTION

MEDIA

Cleaning media is required for use in the CoolingCare System. The media comes in powder form and is dispersed via a filtration basket (see images below). Please reference the User Manual that comes with your unit for complete details.

Choosing which media to order will depend on the type of sediment/corrosion in your channels.

- DS1 - 10kg (1 box contains (4) 2.5kg bricks)

DS1 is formulated for cleaning sediment with high concentrations of iron oxides/corrosion by-products. Scale with high amounts of iron oxide will be reddish/brown in color. To test if the iron oxide content is high move a magnet under the plastic box containing the scale particles. If the particles follow the movement of the magnet, the content is high in iron oxides. This formula includes corrosion inhibitors and surfactants.

- DS2 - 10kg (1 box contains (4) 2.5kg bricks)

DS2 is formulated for cleaning scale based on calcium and magnesium carbonates. The calcium carbonate scale is usually white or yellowish in color. Please bear in mind the composition of scale will usually have different ingredients, the only difference will be the ratio of their concentration. This formula includes corrosion inhibitors and surfactants.



2,5kg packed vacuum powder media (4 packs per box)

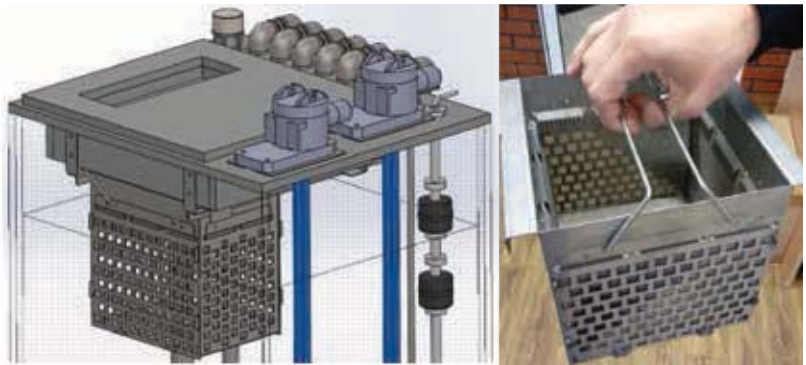

**Media should be disposed of in accordance with local, state and government regulations.*

ADDITIONAL 2KW HEATER

Machines can be ordered with an additional 2kW heater for a total of 6kW of heating capacity. The additional heater reduces the heating time of the cleaning media by up to 50 % (with one heater it takes approximately 40 minutes to reach to the required 50°C, with two heaters the time is reduced to only 25 minutes).

For large molds the use of (2) 2kW heaters is highly recommended to maintain the suggested 50°C temperature of cleaning media. Large mold bases absorb more heat from the media which would result in longer cleaning cycles and lessens the effectiveness of the cleaning process.

PRECISION LEAK DETECTION

Precision Leakage Detection option allows the machine to identify leaks as small as 100ml / 0.026 gallon. This allows the machine to quickly identify a leak/crack within the cooling channel circuit. This option shuts the machines pumps down avoiding any fluid losses.

TECHNICAL INFORMATIONS

	CA-2 two-channel	CA/6 six/channel
Cleaning medium temperature	50 °C	50°C
Container 1 volume	100 L	100 L
Container 2 volume	40 L	100 L
Operating pressure	max. 7 bar	max. 7 bar
Maximum pump capacity	2 x 25 L/min	6 x 25 L/min
Medium connection	4 x Rp 1/2	12 x Rp 3/4
Control voltage	230 V AC	230 V AC/3x400 V AC*
Air consumption	Max 0.5 m ³ /min	Max 1,5 m ³ /min
Power consumption	2,2 kW	2,2 kW/6,0 kW*
Tare weight	188 kg	415 kg
Dimensions (L x W x H)	1014x581x1120 [mm]	1860x740x1120 [mm]
Control Panel	Touch screen 10,1"	Touch screen 10,1"

Device	CA-2 / CA-6
CLEANING MODULE	
Full automation of the cleaning process	✓
Simultaneous cleaning of multiple channels with different diameters	✓
Automatic drying of channels with compressed air	✓
Inlet and outlet filtration	✓
pH measurement	Manual
Separate containers for cleaning and neutralizing media	✓
Integrated heating of cleaning medium	✓
Run dry protection	✓
Automated container filling and emptying	✓
Dedicated cleaning mode for clogged channels	✓
Flow reversal	Pulsator
DIAGNOSTIC MODULE	
Automatic diagnostics with unmanned switch to cleaning mode	✓
Overall verification of mold cooling tightness	Automatic
Individual channel tightness verification	Automatic
Software verifying patency of individual channels	Automatic
Flow rate measurement with mains water	✓
Diagnostics container flow rate measurement	✓
Automatic conservation after cleaning process	✓
Record of all parameters/works for every mold	✓
Juxtaposition of parameters/work reports for every mold	✓
Device tightness test	✓
Self-diagnostics allowing for identification of malfunction in the case of machine breakdown	✓
Automatic adjustment of work mode depending on the available airflow	✓

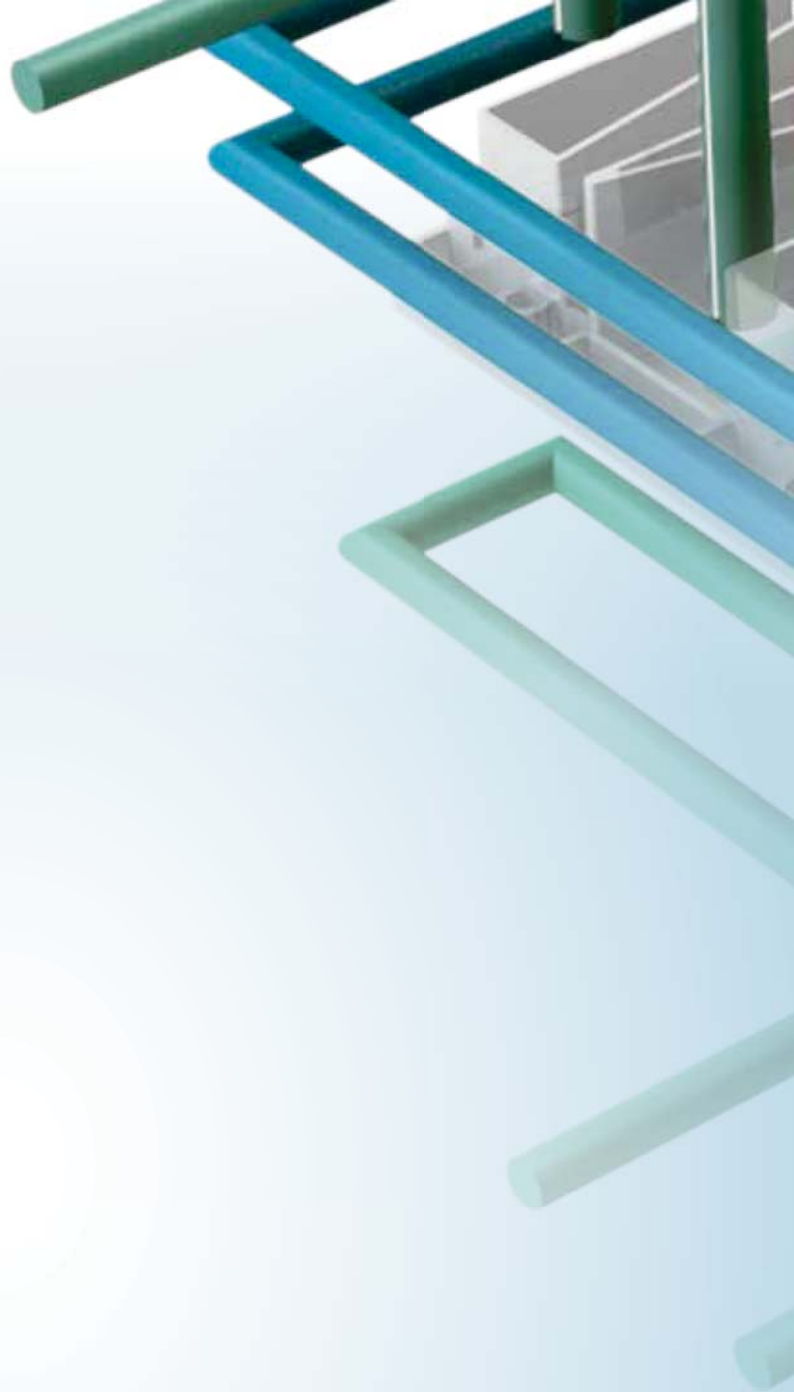

AT

P: 800 301 60
F: 800 401 020
dme_oesterreich@milacron.com

DE

P: 800 664 82 50 | +49 (0) 2351 437 0
F: 800 664 82 51 | +49 (0) 2351 437 220
dme_normalien@milacron.com

IT

P: 800 089 734
F: 800 089 735
dme_italy@milacron.com

SK

P: 800 142 451 | +420 572 151 754
F: 800 142 450 | +420 571 611 996
dme_cz@milacron.com

BE

P: +32 (0) 15 28 87 30
F: +32 (0) 15 40 51 17
dme_benelux@milacron.com

ES

P: 900 900 342
F: 900 900 343
dme_iberia@milacron.com

NL

P: +31 (0) 20 654 5571
F: +31 (0) 20 654 5572
dme_benelux@milacron.com

UK

P: +44 2071 3300 37
F: +44 2071 3300 36
dme_uk@milacron.com

CH

P: +41 0848 567 364
F: +41 0848 567 365
dme_schweiz@milacron.com

FR

P: +33 1 49 93 92 23
F: +33 1 49 93 92 22
dme_france@milacron.com

PL

P: +800 331 1312 | +32 15 21 50 92
F: +800 331 1313 | +32 15 40 51 92
dme_polska@milacron.com

Other countries

P: +32 15 28 87 30
F: +32 15 40 51 17
dme_export@milacron.com

CZ

P: 800 142 451 | +420 572 151 754
F: 800 142 450 | +420 571 611 996
dme_cz@milacron.com

HU

P: 0680 205 003 | +32 15 28 87 30
F: +32 15 40 51 17
dme_hungary@milacron.com

PT

P: 800 207 900
F: 800 207 901
dme_iberia@milacron.com

