

JUNIPER®

JUNIPER-DESIGN.COM

157 WATER STREET SOUTHINGTON, CT 06489

JUNIPER®

MULTIVERSE®  
S Y S T E M  
A NEW GENERATION OF INDOOR POWER DISTRIBUTION

## TABLE OF CONTENTS

### MULTIVERSE® SYSTEM AT A GLANCE

Features and Benefits	5
-----------------------	---

### MULTIVERSE® SYSTEM OVERVIEW

Visual Components Glossary	7
Spotlights	9
Ribbon and Connectors	11
Suspension Adaptors	13
Power	15
Finishes	17
Monopoints	19

### SYSTEM SPECIFICATIONS

Ribbon	21
Ribbon Mounting Hardware	22
Ribbon Connectors In-Plane	23
Ribbon Connectors Out-Of-Plane	24
Power Feed Connectors	25
Standard Kits	26
Suspension Adaptors	28
Spotlights U-Mount	29
Spotlights Monopoint	37
Lenses and Optical Accessories	45
Photometrics Data	49
Power Supply	53
System and Driver Matrix	54
Finishes	55

### LAYOUT GUIDE

Plan	57
Minimum Dimensions	59

Juniper's MULTIVERSE® System\* is a revolutionary, low-voltage power distribution system that redefines the aesthetic and technical capabilities of track lighting. Track segments and connectors are combined to create striking visual motifs spanning as far as 150 linear feet on a single driver, while effortlessly navigating varying topography, corners, and changing planes.

The MULTIVERSE® System's ultra-low, ribbon-like profile conceals its 24V high-efficiency dual circuitry, which is easily installed on nearly any flat surface and can be painted on site to match – or to specification in advance – which allows MULTIVERSE® to discreetly recede into its surroundings or create a bold graphic statement. An intuitive magnetic system connects up to 15 miniature spot modules, which can be rotated, repositioned anywhere along the system's length, or flipped 180° for independent dimming capabilities on the second circuit.

As part of the greater Juniper collection, the patented MULTIVERSE® System can mount most Juniper products via magnetic adaptors, eliminating the need to run internal wiring and turning a fixed lighting plan into a flexible, user-tailored system. Like all Juniper products, MULTIVERSE® is manufactured at the company's Connecticut factory, where each system can be customized to meet any design specification.

\* – MULTIVERSE® System U.S. Patent No. 11,137,132

Patent Notice – this product is protected by patent(s) and/or pending patent application(s) and their corresponding national rights. Information regarding the patent(s) and/or pending patent application(s) can be found at [www.juniper-design.com/patents/](http://www.juniper-design.com/patents/).

## MULTIVERSE® SYSTEM AT A GLANCE

### FEATURES AND BENEFITS

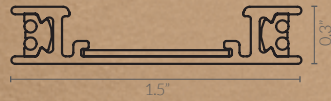

#### ULTRA-LOW PROFILE TRACK

Magnetic connection  
Surface mounts to almost any material

#### DIMMING

2 circuits  
0-10V or phase  
Casambi wireless available

#### SPOTLIGHTS

500, 1000, 1500 LM output  
Field-replaceable beam angles  
21°, 37°, 50° standard  
Precision-machined aluminum  
Full 360° rotation and 0-90° tilt



#### POWER SUPPLIES

24VDC  
Remote and surface mounted options available

#### SUPERIOR LIGHT QUALITY

95+ CRI  
85 LM/Watt delivered average  
Flicker-free dimming to 0.1%

#### CONNECTORS

Inline, 90 Degree Corner, 3-Way, 4-Way,  
and Out-of-Plane

#### COLOR TEMPERATURES

#### VOLTAGE DROP CORRECTION

150' of ribbon can be powered via a single 96W power supply  
Add power supplies for longer runs with seamless continuity and  
no reduction in brightness

#### SIMPLE INSTALLATION

Easy install clip system, field-cuttable  
Junction box covers  
Surface-mounted power supplies

#### LUMINAIRE FINISHES

High-performance coatings  
Matte White, Matte Black, Satin Aluminum, Satin Brass, Custom colors

#### RIBBON AND CONNECTOR FINISHES

High performance coatings  
Primer is field paintable

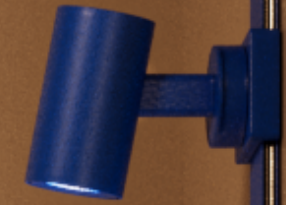

# MULTIVERSE® SYSTEM OVERVIEW

## VISUAL COMPONENTS GLOSSARY

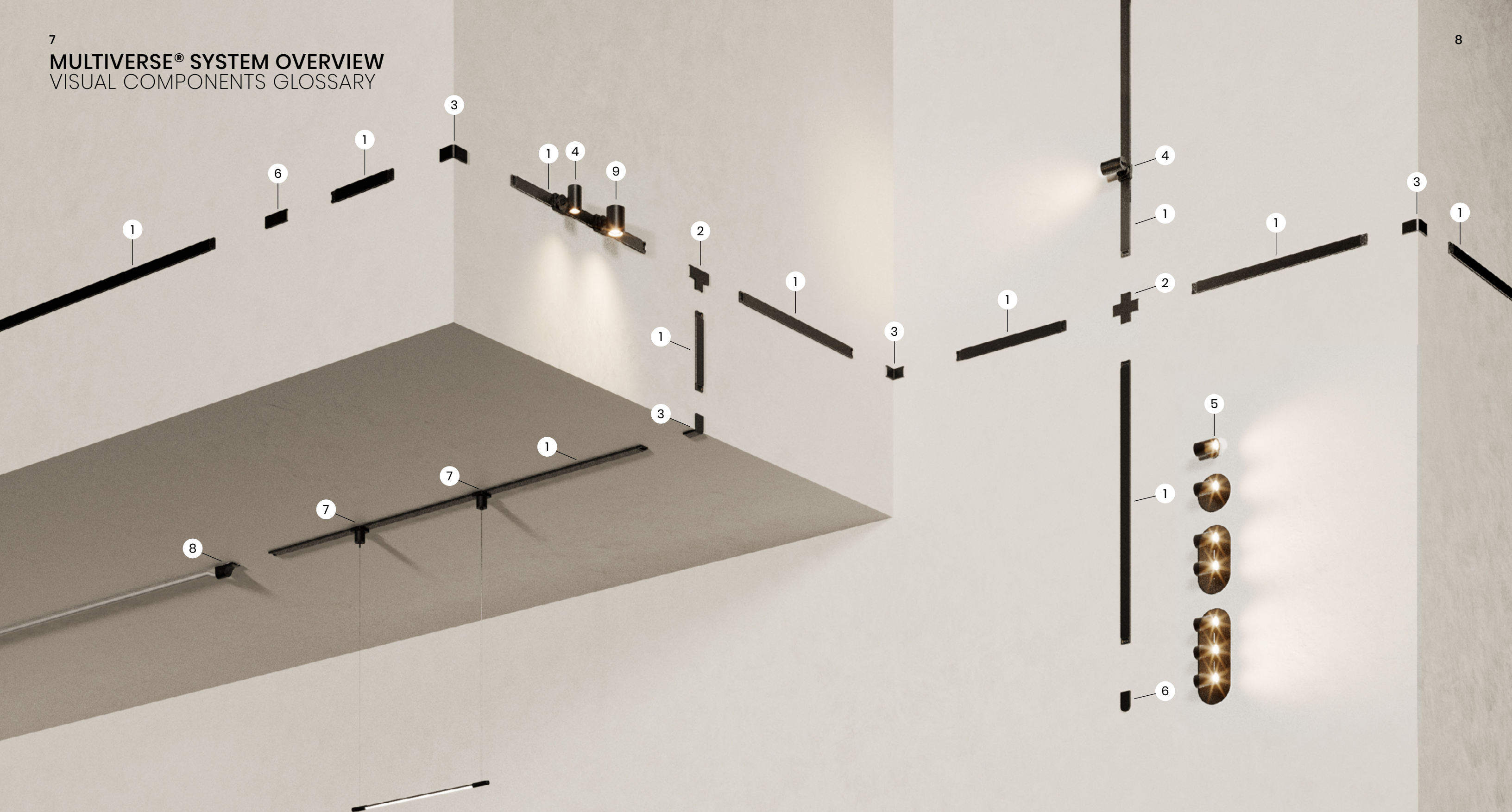

Ribbon adaptors allow for the use of other Juniper fixtures.  
[Inquire](#) for details.

**1 RIBBON**

**2 RIBBON CONNECTORS IN-PLANE**

**3 RIBBON CONNECTORS OUT-OF-PLANE**

**4 SPOTLIGHTS 45MM RIBBON-MOUNTED**



**5 SPOTLIGHTS MONOPOINT**

**6 RIBBON POWER FEEDS SURFACE**

**7 RIBBON ADAPTORS SUSPENSION**

**8 POWER FEED CONDUIT**

**9 SPOT LIGHTS 60MM RIBBON-MOUNTED  
POWER SUPPLIES REMOTE (NOT SHOWN)**

# MULTIVERSE® SYSTEM OVERVIEW SPOTLIGHTS

## EASY MAGNETIC POSITIONING

No tools required to move the spotlight – and simply flip it 180° to select between the two standard circuits.

## SUPPORT FOR MANY LUMINAIRES

Up to 15 spotlights can be powered by a single 96W circuit, and more can be added with seamless in-line power feeds.

## TINY MODULES WITH HIGH OUTPUT

500, 1000, 1500 LM output, featuring field replaceable beam angles, full 360° rotation, and 0–90° tilt.

## WIDE RANGE OF FINISHES AND CUSTOM COLORS

Between the exceptional standard finishes and custom color capability, the MULTIVERSE® luminaires are design-ready.

## INDUSTRY-LEADING LIGHT QUALITY AND DIMMING

95+ CRI, 85 LM/Watt delivered average, and flicker free dimming to 0.1%.



## MULTIVERSE® SYSTEM OVERVIEW

### RIBBON AND CONNECTORS

#### MINIMAL

At just 1.5" wide by 0.3" thin, the MULTIVERSE® ribbon works in almost any setting.

#### DESIGNED FOR DESIGNERS

2 circuits standard, surface mount with easy-to-position installation clips.

#### CAN GO ANYWHERE

A series of pivot elements make for easy installation on nearly any flat surface and allow the system's segments to effortlessly change planes and navigate corners.

#### FIELD PAINTABLE

Blend the track seamlessly into a design by painting it to match existing surfaces.

#### STANDALONE AESTHETICS

Beautiful on its own, the ribbon is designed to add architectural detail to a space.



### EXPANDABLE

The 24VDC system allows the use of select THIN System fixtures to coordinate across Juniper's collections.

### POWERFUL

Use one circuit for spots and the other with linear suspension luminaires for complex layers of light.

### DESIGNED FOR CREATING

The luminaire adaptors combined with Juniper's exceptional finishes make this an infinitely expressive system.

Updated: 07/12/2023

Updated: 07/12/2023



## MULTIVERSE® SYSTEM OVERVIEW

### POWER

#### MULTIPLE POWER FEED OPTIONS

Connect the system with or without junction boxes, for inline, corner, and end feeds.

#### DIMMABLE

Standard options include 120–277V AC input, forward-phase, reverse-phase, and 0–10V dimming.

#### EFFICIENT

96W of power allows for up to 15 spotlights on one circuit; simply add more power supplies to expand the system.

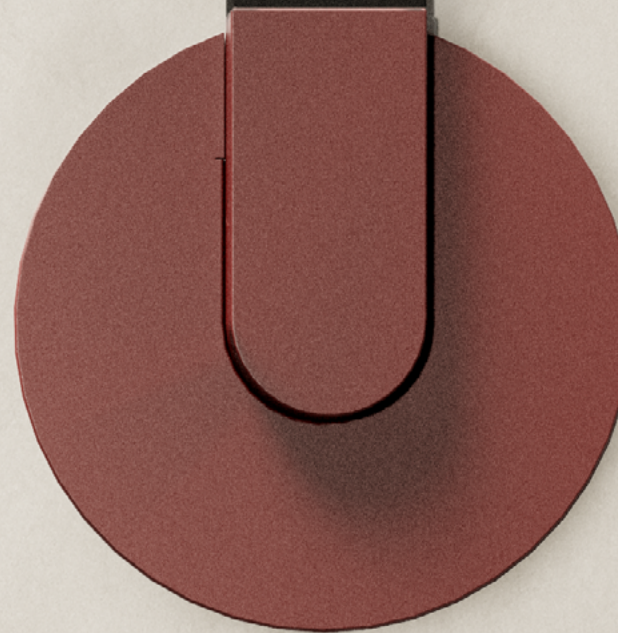

# MULTIVERSE® SYSTEM OVERVIEW FINISHES

## EXCEPTIONAL FINISHES

- High performance coatings, powder coats, and plated metallics.
- Primer field-paintable ribbon and connectors.
- Matte White, Matte Black, Satin Aluminum, Satin Brass and Custom colors – see [Finishes](#) section for details.

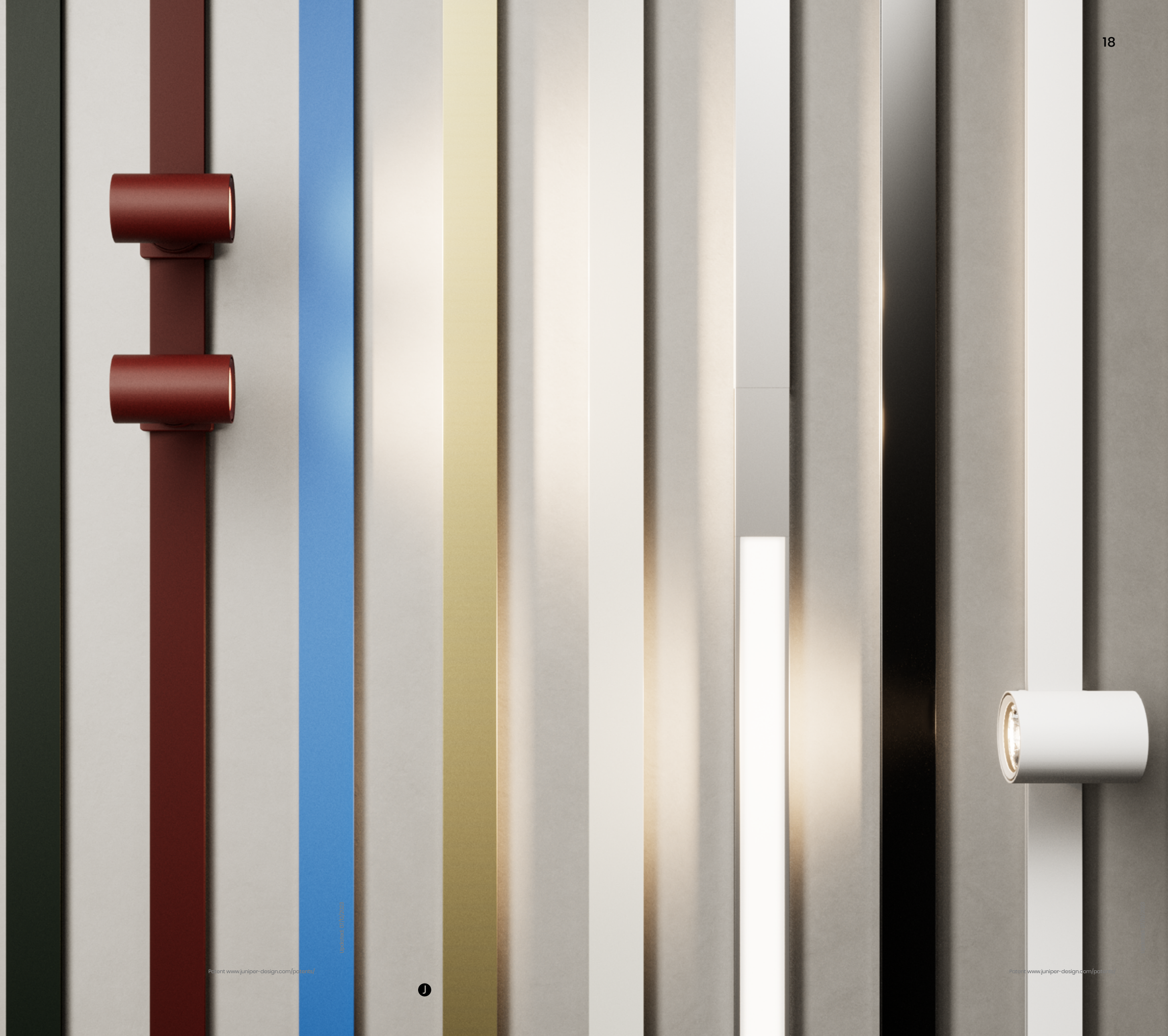

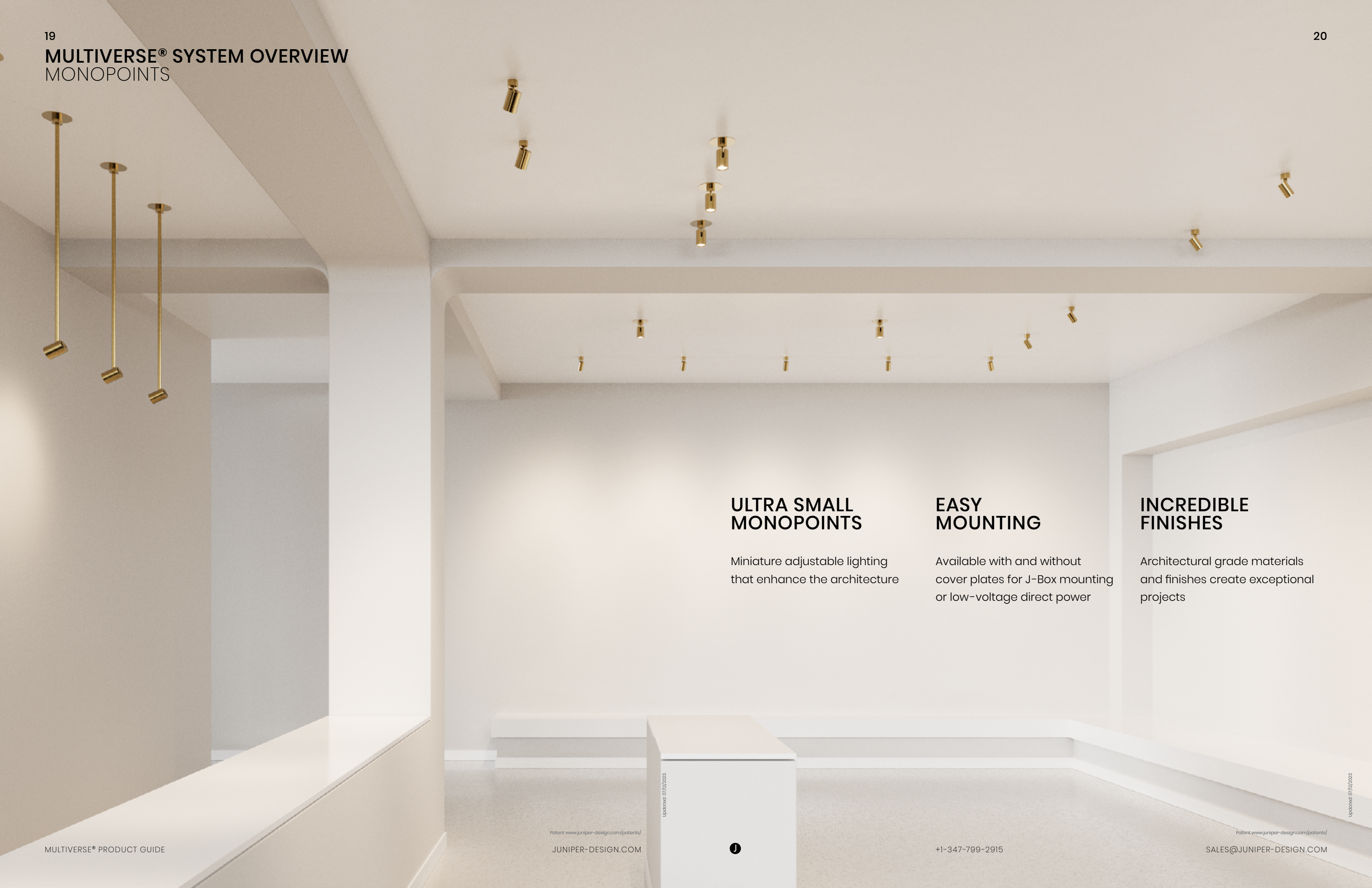

### ULTRA SMALL MONOPOINTS

Miniature adjustable lighting  
that enhance the architecture

### EASY MOUNTING

Available with and without  
cover plates for J-Box mounting  
or low-voltage direct power

### INCREDIBLE FINISHES

Architectural grade materials  
and finishes create exceptional  
projects

# SYSTEM SPECIFICATIONS

## RIBBON

- The low profile heart of the MULTIVERSE® System
- Field cuttable (see [Layout Guide](#) for details)
- 2 circuits standard – change circuit by reversing fixture on the ribbon
- All components must be ordered separately except where noted
- Primer is field-paintable
- See [Finishes](#) page for full finish selection options
- Each ribbon/track comes with one Track End Coupler Interface on each end; must be removed before field cutting

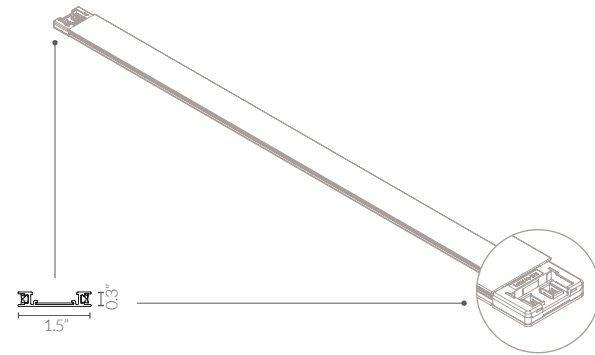

ITEM	INCL. CLIPS	QTY	FINISH	PART NUMBER
<b>2 FT RIBBON</b> 	2	32 BLACK	JPR-MLTV-TRK1-002-32	
		33 SATIN ALUMINUM	JPR-MLTV-TRK1-002-33	
		30 WHITE	JPR-MLTV-TRK1-002-30	
		31 PRIMER	JPR-MLTV-TRK1-002-31	
		32 BLACK	JPR-MLTV-TRK1-004-32	
<b>4 FT RIBBON</b> 	3	33 SATIN ALUMINUM	JPR-MLTV-TRK1-004-33	
		30 WHITE	JPR-MLTV-TRK1-004-30	
		31 PRIMER	JPR-MLTV-TRK1-004-31	
		32 BLACK	JPR-MLTV-TRK1-006-32	
<b>6 FT RIBBON</b> 	4	33 SATIN ALUMINUM	JPR-MLTV-TRK1-006-33	
		30 WHITE	JPR-MLTV-TRK1-006-30	
		31 PRIMER	JPR-MLTV-TRK1-006-31	

Each ribbon segment includes an appropriate amount of clips determined by the length – clips should be mounted within 3 inches of each end of the ribbon segment, with no more than 18 inches between clips.

# SYSTEM SPECIFICATIONS

## RIBBON MOUNTING HARDWARE

The surface mounting clip takes a #6 screw and can be attached to any horizontal or vertical surface (with appropriate anchoring hardware). Ribbon segments then snap onto the clip, and can be released by inserting a flat-head screwdriver (or the provided tool) under the ribbon to depress the catch mechanism.

The appropriate quantity of clips is included with each track length. Additional clips may be purchased separately if needed.

ITEM	PART NUMBER
<b>SURFACE MOUNT CLIP</b> <p>Mounts the ribbon to any flat surface with a #6 pan-head screw</p>	RAS-0112-WM

For more details, see [Layout Guide](#).







# SYSTEM SPECIFICATIONS

## RIBBON CONNECTORS

### IN-PLANE

A connector or power feed is required at the end of all ribbon segments.

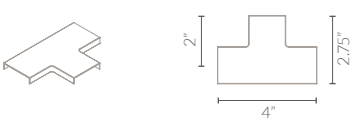
All connectors allow for pass through of the circuit; to isolate the ends of the track, add provided Isolating Tape to the track ends.



ITEM	FINISH	PART NUMBER
<b>END CAP</b> Terminates one end of a ribbon segment 	32 BLACK	JPR-MLTV-CON1-EC-32
	33 SATIN ALUMINUM	JPR-MLTV-CON1-EC-33
	30 WHITE	JPR-MLTV-CON1-EC-30
	31 PRIMER	JPR-MLTV-CON1-EC-31
<b>INLINE</b> Connects two ribbon segments 	32 BLACK	JPR-MLTV-CON1-IL-32
	33 SATIN ALUMINUM	JPR-MLTV-CON1-IL-33
	30 WHITE	JPR-MLTV-CON1-IL-30
	31 PRIMER	JPR-MLTV-CON1-IL-31
<b>90 DEGREE CORNER</b> Connects two ribbon segments at 90° 	32 BLACK	JPR-MLTV-CON1-90-32
	33 SATIN ALUMINUM	JPR-MLTV-CON1-90-33
	30 WHITE	JPR-MLTV-CON1-90-30
	31 PRIMER	JPR-MLTV-CON1-90-31
<b>3-WAY</b> Connects three ribbon segments at 90° 	32 BLACK	JPR-MLTV-CON1-3W-32
	33 SATIN ALUMINUM	JPR-MLTV-CON1-3W-33
	30 WHITE	JPR-MLTV-CON1-3W-30
	31 PRIMER	JPR-MLTV-CON1-3W-31
<b>4-WAY</b> Connects four ribbon segments at 90° 	32 BLACK	JPR-MLTV-CON1-4W-32
	33 SATIN ALUMINUM	JPR-MLTV-CON1-4W-33
	30 WHITE	JPR-MLTV-CON1-4W-30
	31 PRIMER	JPR-MLTV-CON1-4W-31

Please contact Juniper for alternate configurations.

# SYSTEM SPECIFICATIONS

## RIBBON CONNECTORS

### OUT-OF-PLANE

ITEM	FINISH	PART NUMBER
<b>INSIDE CORNER</b> Connects two ribbon segments at 90°, as in the intersection of a wall and a ceiling 	32 BLACK	JPR-MLTV-CON1-IC-32
	33 SATIN ALUMINUM	JPR-MLTV-CON1-IC-33
	30 WHITE	JPR-MLTV-CON1-IC-30
	31 PRIMER	JPR-MLTV-CON1-IC-31
<b>OUTSIDE CORNER</b> Connects two ribbon segments at 90°, as in the intersection of two walls 	32 BLACK	JPR-MLTV-CON1-OC-32
	33 SATIN ALUMINUM	JPR-MLTV-CON1-OC-33
	30 WHITE	JPR-MLTV-CON1-OC-30
	31 PRIMER	JPR-MLTV-CON1-OC-31

For additional mounting and dimension information, see [Minimum Dimensions](#).

All connectors allow for pass through of the circuit; to isolate the ends of the track, add provided Isolating Tape to the track ends.

Please contact Juniper for alternate configurations.

# SYSTEM SPECIFICATIONS



## POWER FEED CONNECTORS

A power feed is required to bring low-voltage 24VDC power to the track. Each feed can accommodate connections for up to (2) 96W circuits. Junction box cover plates are available, though not required. Minimum 14 AWG feeder cable is recommended to minimize voltage drop – see Power Supply section for details.

ITEM	FINISH	PART NUMBER
<b>INLINE</b> Direct wire with low voltage cable; can feed in both directions; can be mounted to surface or standard 4" octagon box	32 BLACK	JPR-MLTV-RPF1-J-IL-32
	33 SATIN ALUMINUM	JPR-MLTV-RPF1-J-IL-33
	30 WHITE	JPR-MLTV-RPF1-J-IL-30
	31 PRIMER	JPR-MLTV-RPF1-J-IL-31
<b>END</b> Direct wire with low voltage cable; feeds in one direction; can be mounted to surface or standard 4" octagon box	32 BLACK	JPR-MLTV-RPF1-J-EF-32
	33 SATIN ALUMINUM	JPR-MLTV-RPF1-J-EF-33
	30 WHITE	JPR-MLTV-RPF1-J-EF-30
	31 PRIMER	JPR-MLTV-RPF1-J-EF-31
<b>90 DEGREE CORNER</b> Direct wire with low voltage cable; can feed in both directions; can be mounted to surface or standard 4" octagon box	32 BLACK	JPR-MLTV-RPF1-J-90-32
	33 SATIN ALUMINUM	JPR-MLTV-RPF1-J-90-33
	30 WHITE	JPR-MLTV-RPF1-J-90-30
	31 PRIMER	JPR-MLTV-RPF1-J-90-31
<b>CONDUIT</b> Accepts conduit via 1/2" knockout, feeds in one direction	32 BLACK	JPR-MLTV-RPF1-S-CF-32
	33 SATIN ALUMINUM	JPR-MLTV-RPF1-S-CF-33
	30 WHITE	JPR-MLTV-RPF1-S-CF-30
	31 PRIMER	JPR-MLTV-RPF1-S-CF-31

# SYSTEM SPECIFICATIONS

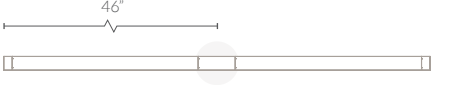
## STANDARD KITS

ITEM	PARTS INCLUDED	PART NUMBER	UNITS
<b>4FT KIT – END FEED</b>  J-Box Cover Plate optional	TRACK 4' – 3 CLIPS	JPR-MLTV-TRK1-004-XX	1
	END CAP	JPR-MLTV-CON1-EC-XX	1
	END POWER FEED – REMOTE SURFACE MOUNT (J-BOX)	JPR-MLTV-RPF1-J-EF-XX	1
	<b>JPR-MLTV-KIT1-ST-0004-R-J-EF-XX</b>		
<b>4FT KIT – INLINE FEED</b>  J-Box Cover Plate optional	TRACK 2' – 2 CLIPS	JPR-MLTV-TRK1-002-XX	2
	END CAP	JPR-MLTV-CON1-EC-XX	2
	INLINE POWER FEED – REMOTE SURFACE MOUNT (J-BOX)	JPR-MLTV-RPF1-J-IL-XX	1
	<b>JPR-MLTV-KIT1-ST-0004-R-J-IL-XX</b>		
<b>6FT KIT – END FEED</b>  J-Box Cover Plate optional	TRACK 6' – 4 CLIPS	JPR-MLTV-TRK1-006-XX	1
	END CAP	JPR-MLTV-CON1-EC-XX	1
	END POWER FEED – REMOTE SURFACE MOUNT (J-BOX)	JPR-MLTV-RPF1-J-EF-XX	1
	<b>JPR-MLTV-KIT1-ST-0006-R-J-EF-XX</b>		

Spotlights and power supplies are purchased separately.



# SYSTEM SPECIFICATIONS

## STANDARD KITS

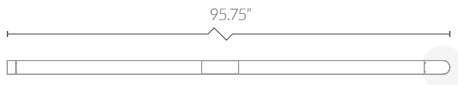
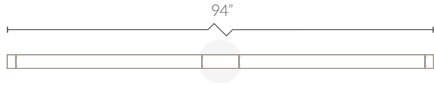
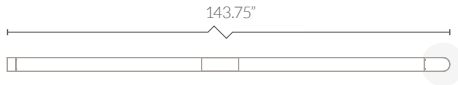
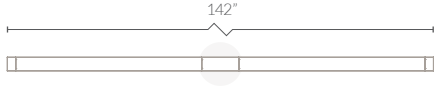

ITEM	PARTS INCLUDED	PART NUMBER	UNITS
<b>8FT KIT — END FEED</b>	<b>8FT KIT — END FEED</b>	<b>JPR-MLTV-KIT1-ST-0008-R-J-EF-XX</b>	
	TRACK 4' — 3 CLIPS	JPR-MLTV-TRK1-004-XX	2
	END CAP	JPR-MLTV-CON1-EC-XX	1
	END POWER FEED — REMOTE SURFACE MOUNT (J-BOX)	JPR-MLTV-RPF1-J-EF-XX	1
	INLINE CONNECTOR	JPR-MLTV-CON1-IL-XX	1
J-Box Cover Plate optional			
<b>8FT KIT — INLINE FEED</b>	<b>8FT KIT — INLINE FEED</b>	<b>JPR-MLTV-KIT1-ST-0008-R-J-IL-XX</b>	
	TRACK 4' — 3 CLIPS	JPR-MLTV-TRK1-004-XX	2
	END CAP	JPR-MLTV-CON1-EC-XX	2
	INLINE POWER FEED — REMOTE SURFACE MOUNT (J-BOX)	JPR-MLTV-RPF1-J-IL-XX	1
J-Box Cover Plate optional			
<b>12FT KIT — END FEED</b>	<b>12FT KIT — END FEED</b>	<b>JPR-MLTV-KIT1-ST-0012-R-J-EF-XX</b>	
	TRACK 6' — 4 CLIPS	JPR-MLTV-TRK1-006-XX	2
	END CAP	JPR-MLTV-CON1-EC-XX	1
	END POWER FEED — REMOTE SURFACE MOUNT (J-BOX)	JPR-MLTV-RPF1-J-EF-XX	1
	INLINE CONNECTOR	JPR-MLTV-CON1-IL-XX	1
J-Box Cover Plate optional			
<b>12FT KIT — INLINE FEED</b>	<b>12FT KIT — INLINE FEED</b>	<b>JPR-MLTV-KIT1-ST-0012-R-J-IL-XX</b>	
	TRACK 6' — 4 CLIPS	JPR-MLTV-TRK1-006-XX	2
	END CAP	JPR-MLTV-CON1-EC-XX	2
	INLINE POWER FEED — REMOTE SURFACE MOUNT (J-BOX)	JPR-MLTV-RPF1-J-IL-XX	1
J-Box Cover Plate optional			

Spotlights and power supplies are purchased separately.

# SYSTEM SPECIFICATIONS

## SUSPENSION ADAPTORS

Suspension Adaptors allow for select 24VDC Juniper lighting to be suspended from the track — a powered adaptor is required for the power feed, and a non-powered adaptor is required for additional aircraft cable mounting points.

ITEM		FINISH	PART NUMBER
<b>SUSPENSION ADAPTOR POWERED</b>		32 BLACK	JPR-MLTV-ADP1-P-32
Connects 24VDC suspension luminaires < 5lbs to the MULTIVERSE® ribbon — accepts Juniper coaxial cable		33 SATIN ALUMINUM	JPR-MLTV-ADP1-P-33
		30 WHITE	JPR-MLTV-ADP1-P-30
<b>SUSPENSION ADAPTOR LOAD   NON-POWERED</b>		32 BLACK	JPR-MLTV-ADP1-L-32
Connects 24VDC suspension luminaires < 5lbs to the MULTIVERSE® ribbon — accepts 3/64 aircraft cable		33 SATIN ALUMINUM	JPR-MLTV-ADP1-L-33
		30 WHITE	JPR-MLTV-ADP1-L-30
<b>SUSPENSION ADAPTOR LOAD   POWERED</b>		32 BLACK	JPR-MLTV-ADP1-D-32
Connects 24VDC suspension luminaires < 5lbs to the MULTIVERSE® ribbon — accepts 3/64 aircraft cable and JUNIPER coaxial cable		33 SATIN ALUMINUM	JPR-MLTV-ADP1-D-33
		30 WHITE	JPR-MLTV-ADP1-D-30



# SYSTEM SPECIFICATIONS

## SPOTLIGHTS U-MOUNT

### 45 MM, STANDARD STEM

#### SPECIFICATION BUILDER

JPR-MLTV-SPT1-	45	050	A	STND			N	
	1	2	3	4	5	6	7	8

MODEL	1. SIZE	2. OUTPUT	3. DIMMING	4. STEM
JPR-MLTV-SPT1-	45 45 MM DIAMETER	050 500LM / 5.1W	A 1%	STND STANDARD (2.2")

5. CCT	6. BEAM SPREAD	7. ACCESSORY SLOT	8. FINISH
27 2700K	NR NARROW (22)	N NONE (SPACER RING)	30 MATTE PURE WHITE
30 3000K	ME MEDIUM (29)	Spacer ring comes standard. See <a href="#">optical accessory kits</a> for field replaceable accessories:	32 MATTE BLACK
35 3500K	WI WIDE (38)		33 SATIN ALUMINUM
40 4000K	XW EXTRA WIDE (65)	H HEX LOUVER	Stock finishes shown. See <a href="#">Finishes</a> for additional options.
	See <a href="#">lens kits</a> for additional field replaceable lenses	S SOFTENING LENS	
		T SNOOT	

For additional lenses and accessories, see [Lenses and Optical Accessories](#).

For detailed photometrics, see [Photometrics Guide](#).

[IES files](#) available.



# SYSTEM SPECIFICATIONS

## SPOTLIGHTS U-MOUNT

### 45 MM, STANDARD STEM

- CRI 95-98
- R9 94-99
- Rf 96-98
- Rg 99-102
- 85-90 LM/W delivered efficacy
- Standard ribbon-mounted spotlight
- Features proprietary one-handed side-load clamp mechanism
- Change between ribbon circuits by reversing orientation on the ribbon
- Field-replaceable lenses and accessories available
- Fully 360 degree/0-90 degree adjustable

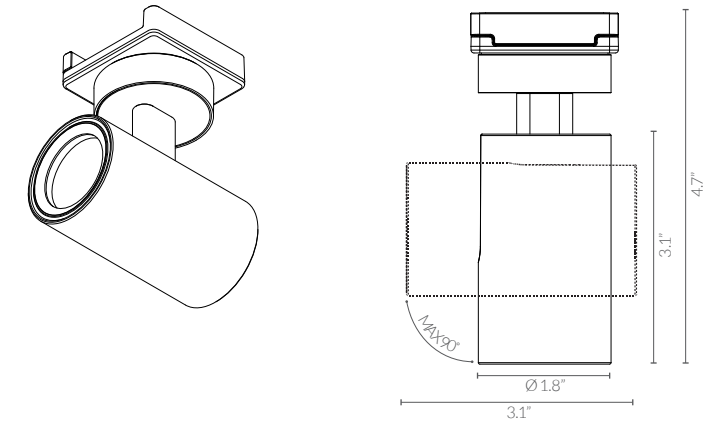

#### SPOTLIGHT 500LM | 3000K

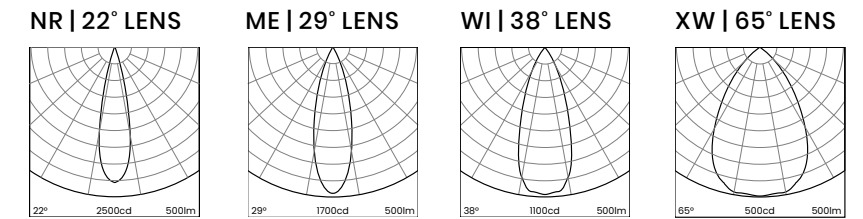

# SYSTEM SPECIFICATIONS

## SPOTLIGHTS U-MOUNT

### 60 MM, STANDARD STEM

#### SPECIFICATION BUILDER

JPR-MLTV-SPT1-	60		A	STND			N	
	1	2	3	4	5	6	7	8

MODEL	1. SIZE	2. OUTPUT	3. DIMMING	4. STEM
JPR-MLTV-SPT1-	60 60 MM DIAMETER	100 1000LM / 10.9W 150 1500LM / 17.1W	A 1%	STND STANDARD (2.2")

5. CCT	6. BEAM SPREAD	7. ACCESSORY SLOT	8. FINISH
27 2700K	NR NARROW (20)	N NONE (SPACER RING)	30 MATTE PURE WHITE
30 3000K	ME MEDIUM (28)	Spacer ring comes standard. See <a href="#">optical accessory kits</a> for field replaceable accessories:	32 MATTE BLACK
35 3500K	WI WIDE (39)		33 SATIN ALUMINUM
40 4000K	XW EXTRA WIDE (64)	H HEX LOUVER	Stock finishes shown. See <a href="#">Finishes</a> for additional options.
	See <a href="#">lens kits</a> for additional field replaceable lenses	S SOFTENING LENS	
		T SNOOT	

For additional lenses and accessories, see [Lenses and Optical Accessories](#).

For detailed photometrics, see [Photometrics Guide](#).

[IES files](#) available.



# SYSTEM SPECIFICATIONS

## SPOTLIGHTS U-MOUNT

### 60 MM, STANDARD STEM

- CRI 95-98
- R9 94-99
- Rf 96-98
- Rg 99-102
- 85-90 LM/W delivered efficacy
- Standard ribbon-mounted spotlight
- Features proprietary one-handed side-load clamp mechanism
- Change between ribbon circuits by reversing orientation on the ribbon
- Field-replaceable lenses and accessories available
- Fully 360 degree/0-90 degree adjustable

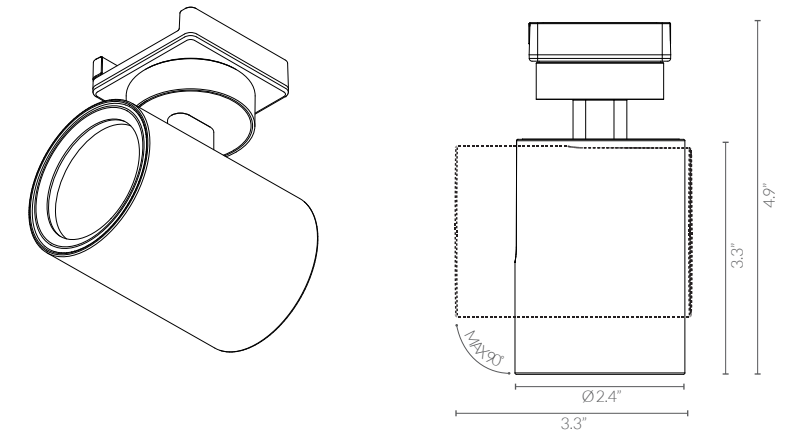

#### SPOTLIGHT 1000LM | 3000K

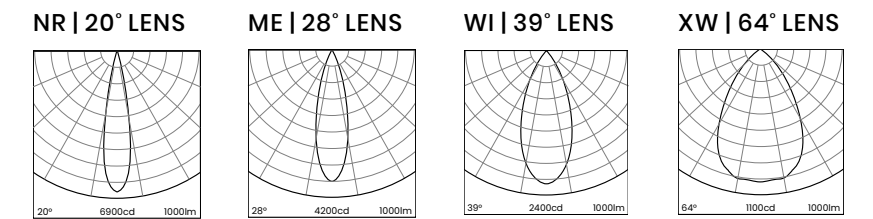

#### SPOTLIGHT 1500LM | 3000K

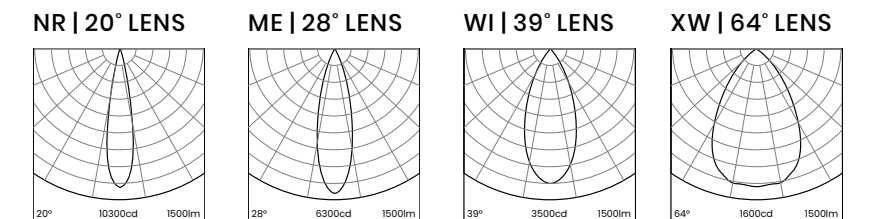

# SYSTEM SPECIFICATIONS

## SPOTLIGHTS U-MOUNT

### 45 MM, LONG STEM

#### SPECIFICATION BUILDER

JPR-MLTV-SPT1- **45** **050** **A** **N**

1 2 3 4 5 6 7 8

MODEL	1. SIZE	2. OUTPUT	3. DIMMING	4. STEM
JPR-MLTV-SPT1-	45 45 MM DIAMETER	050 500LM/ 5.1W	A 1%	0006 6" 0012 12" 0018 18" 0024 24" CUXX CUSTOM Maximum length 24"
	5. CCT	6. BEAM SPREAD	7. ACCESSORY SLOT	8. FINISH
	27 2700K 30 3000K 35 3500K 40 4000K	NR NARROW (22) ME MEDIUM (29) WI WIDE (38) XW EXTRA WIDE (65) See <a href="#">lens kits</a> for additional field replaceable lenses	N NONE (SPACER RING) Spacer ring comes standard. See <a href="#">optical accessory kits</a> for field replaceable accessories: H HEX LOUVER S SOFTENING LENS T SNOOT	30 MATTE PURE WHITE 32 MATTE BLACK 33 SATIN ALUMINUM Stock finishes shown. See <a href="#">Finishes</a> for additional options.

For additional lenses and accessories, see [Lenses and Optical Accessories](#).

For detailed photometrics, see [Photometrics Guide](#).

[IES files](#) available.



# SYSTEM SPECIFICATIONS

## SPOTLIGHTS U-MOUNT

### 45 MM, LONG STEM

- CRI 95-98
- R9 94-99
- Rf 96-98
- Rg 99-102
- 85-90 LM/W delivered efficacy
- Standard ribbon-mounted spotlight
- Features proprietary one-handed side-load clamp mechanism
- Change between ribbon circuits by reversing orientation on the ribbon
- Field-replaceable lenses and accessories available
- Fully 360 degree/0-90 degree adjustable

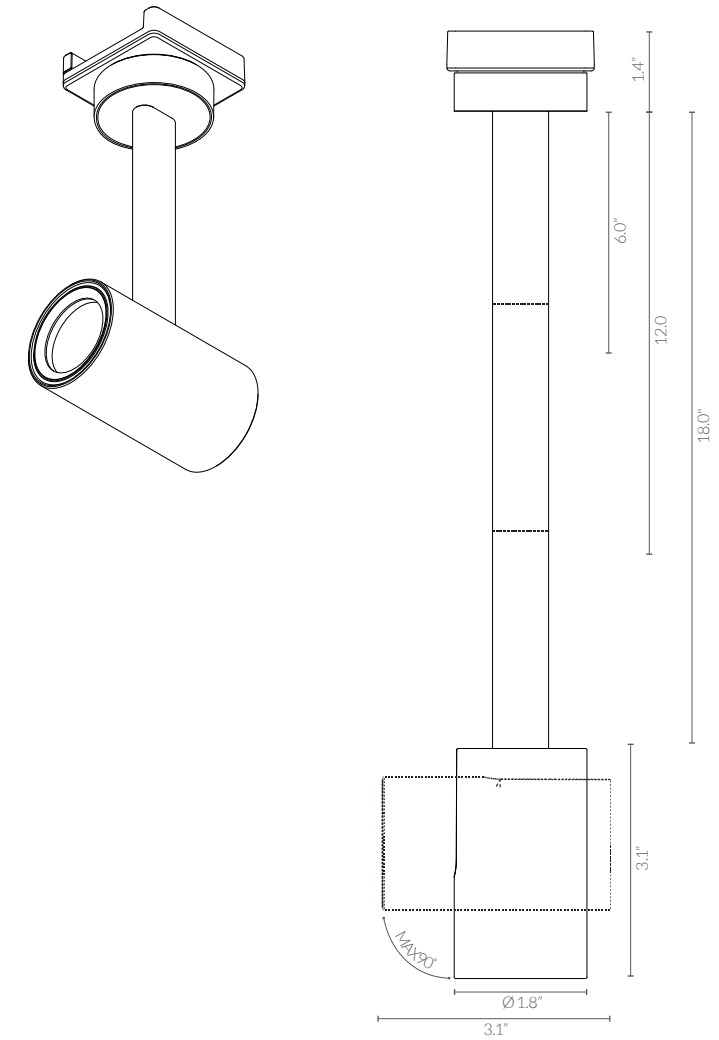

#### SPOTLIGHT 500LM | 3000K

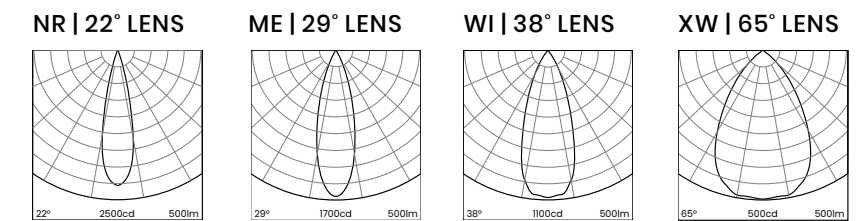

# SYSTEM SPECIFICATIONS

## SPOTLIGHTS U-MOUNT

### 60 MM, LONG STEM

#### SPECIFICATION BUILDER



MODEL	1. SIZE	2. OUTPUT	3. DIMMING	4. STEM
JPR-MLTV-SPT1-	60 60 MM DIAMETER	100 1000LM / 10.9W 150 1500LM / 17.1W	A 1%	0006 6" 0012 12" 0018 18" 0024 24" CUXX CUSTOM Maximum length 24"
	5. CCT	6. BEAM SPREAD	7. ACCESSORY SLOT	8. FINISH
	27 2700K 30 3000K 35 3500K 40 4000K	NR NARROW (20) ME MEDIUM (28) WI WIDE (39) XW EXTRA WIDE (64) See <a href="#">lens kits</a> for additional field replaceable lenses	N NONE (SPACER RING) Spacer ring comes standard. See <a href="#">optical accessory kits</a> for field replaceable accessories: H HEX LOUVER S SOFTENING LENS T SNOOT	30 MATTE PURE WHITE 32 MATTE BLACK 33 SATIN ALUMINUM Stock finishes shown. See <a href="#">Finishes</a> for additional options.

For additional lenses and accessories, see [Lenses and Optical Accessories](#).  
For detailed photometrics, see [Photometrics Guide](#).  
[IES files](#) available.



# SYSTEM SPECIFICATIONS

## SPOTLIGHTS U-MOUNT

### 60 MM, LONG STEM

- CRI 95-98
- R9 94-99
- Rf 96-98
- Rg 99-102
- 85-90 LM/W delivered efficacy
- Standard ribbon-mounted spotlight
- Features proprietary one-handed side-load clamp mechanism
- Change between ribbon circuits by reversing orientation on the ribbon
- Field-replaceable lenses and accessories available
- Fully 360 degree/0-90 degree adjustable

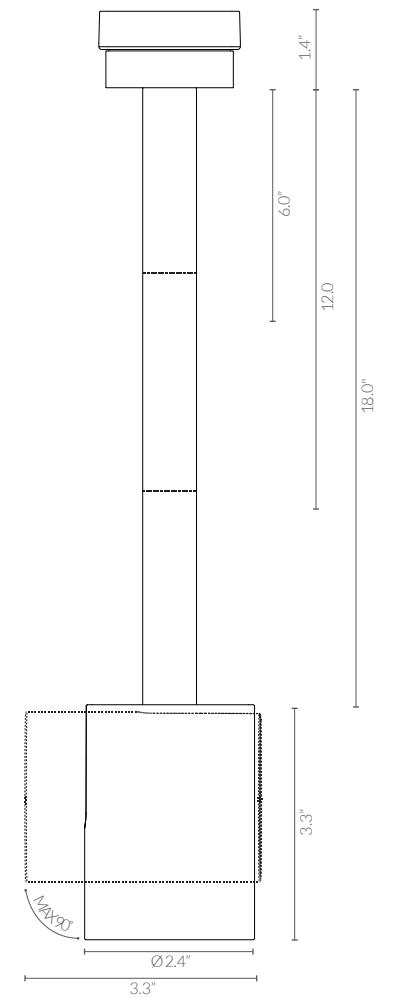
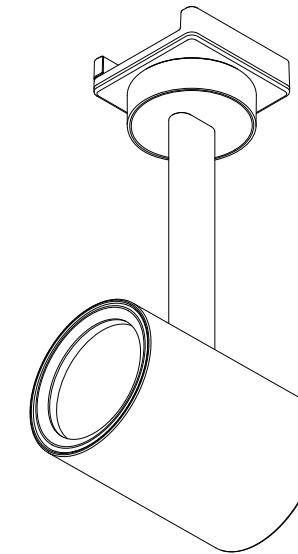

#### SPOTLIGHT 1000LM | 3000K

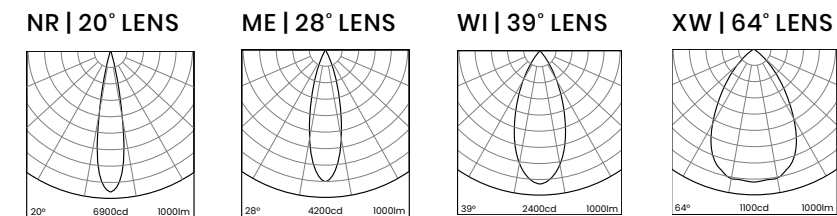

#### SPOTLIGHT 1500LM | 3000K

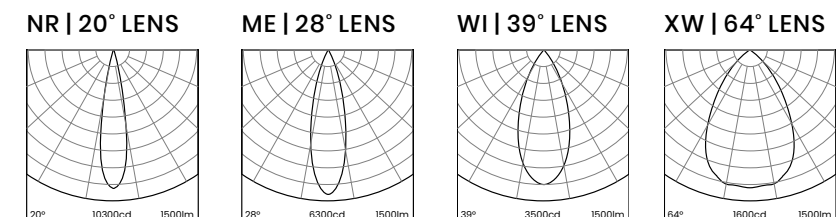

# SYSTEM SPECIFICATIONS

## SPOTLIGHTS MONOPOINT

### 45 MM, STANDARD STEM

#### SPECIFICATION BUILDER

JPR-MLTV-MPT1-	<b>45</b>	<b>050</b>	<b>A</b>	<b>STND</b>		<b>N</b>	
	1	2	3	4	5	6	7

MODEL	1. SIZE	2. OUTPUT	3. DIMMING	4. STEM
JPR-MLTV-MPT1-	45 45 MM DIAMETER	050 500LM / 5.1W	A 1%	STND STANDARD (2.2")

5. CCT	6. BEAM SPREAD	7. ACCESSORY SLOT	8. FINISH
27 2700K	<b>NR</b> NARROW (22)	<b>N</b> NONE (SPACER RING)	<b>30</b> MATTE PURE WHITE
30 3000K	<b>ME</b> MEDIUM (29)	Spacer ring comes standard. See <a href="#">optical accessory kits</a> for field replaceable accessories:	<b>32</b> MATTE BLACK
35 3500K	<b>WI</b> WIDE (38)		<b>33</b> SATIN ALUMINUM
40 4000K	<b>XW</b> EXTRA WIDE (65)	<b>H</b> HEX LOUVER	Stock finishes shown. See <a href="#">Finishes</a> for additional options.
	See <a href="#">lens kits</a> for additional field replaceable lenses	<b>S</b> SOFTENING LENS	
		<b>T</b> SNOOT	

ITEM	PART NUMBER
<b>SINGLE PLATE</b> 	JPR-MLTV-MPP1-01-XX
<b>DOUBLE PLATE</b> 	JPR-MLTV-MPP1-02-XX
<b>TRIPLE PLATE</b> 	JPR-MLTV-MPP1-03-XX

Plate includes:

- cross bar for mounting to 4" junction box
- spring clips for use with Plate to mount to 2–4" dia. hole in drywall

For detailed photometrics, see [Photometrics Guide](#).  
[IES files](#) available.

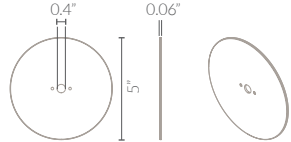
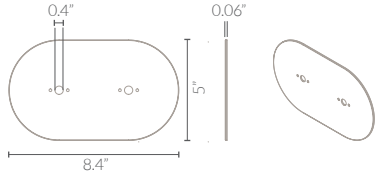
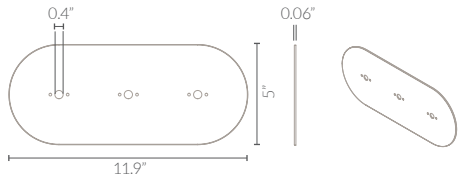

Patent [www.juniper-design.com/patents/](http://www.juniper-design.com/patents/)

JUNIPER-DESIGN.COM

# SYSTEM SPECIFICATIONS

## SPOTLIGHTS MONOPOINT

### 45 MM, STANDARD STEM

- CRI 95-98
- R9 94-99
- Rf 96-98
- Rg 99-102
- 85-90 LM/W delivered efficacy
- Standard accent luminaire powered via 24VDC low voltage power supply
- Hardware included for mounting: #8 toggle bolt for direct mount to surface
- Field-replaceable lenses and accessories available
- Fully 360 degree/0-90 degree adjustable

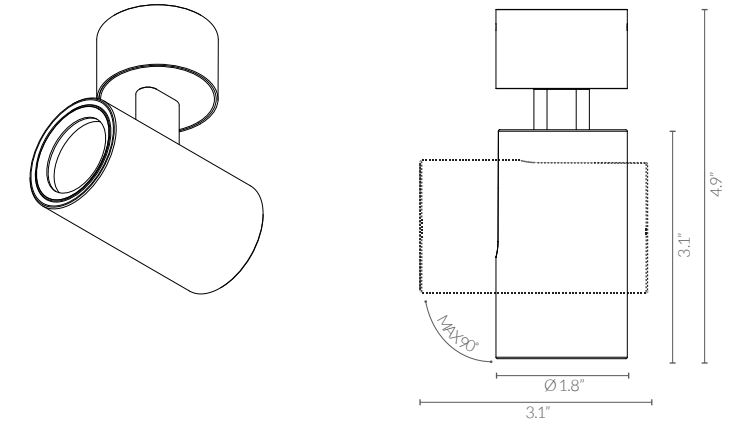

#### MONOPOINT 500LM | 3000K

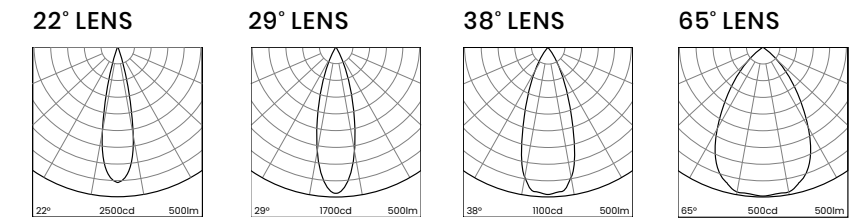

Patent [www.juniper-design.com/patents/](http://www.juniper-design.com/patents/)

SALES@JUNIPER-DESIGN.COM

# SYSTEM SPECIFICATIONS

## SPOTLIGHTS MONOPOINT

### 60 MM, STANDARD STEM

#### SPECIFICATION BUILDER

JPR-MLTV-MPT1- **60** **A** **STND** **N**

1 2 3 4 5 6 7 8

MODEL	1. SIZE	2. OUTPUT	3. DIMMING	4. STEM
JPR-MLTV-MPT1-	<b>60</b> 60 MM DIAMETER	<b>100</b> 1000LM / 10.9W <b>150</b> 1500LM / 17.1W	<b>A</b> 1%	<b>STND</b> STANDARD (2.2")

5. CCT	6. BEAM SPREAD	7. ACCESSORY SLOT	8. FINISH
<b>27</b> 2700K	<b>NR</b> NARROW (20)	<b>N</b> NONE (SPACER RING)	<b>30</b> MATTE PURE WHITE
<b>30</b> 3000K	<b>ME</b> MEDIUM (28)	Spacer ring comes standard. See <a href="#">optical accessory kits</a> for field replaceable accessories:	<b>32</b> MATTE BLACK
<b>35</b> 3500K	<b>WI</b> WIDE (39)		<b>33</b> SATIN ALUMINUM
<b>40</b> 4000K	<b>XW</b> EXTRA WIDE (64)		
	See <a href="#">lens kits</a> for additional field replaceable lenses	<b>H</b> HEX LOUVER <b>S</b> SOFTENING LENS <b>T</b> SNOOT	Stock finishes shown. See <a href="#">Finishes</a> for additional options.

ITEM	PART NUMBER
<b>SINGLE PLATE</b> 	JPR-MLTV-MPP1-01-XX
<b>DOUBLE PLATE</b> 	JPR-MLTV-MPP1-02-XX
<b>TRIPLE PLATE</b> 	JPR-MLTV-MPP1-03-XX

Plate includes: For detailed photometrics, see [Photometrics Guide](#).

- cross bar for mounting to 4" junction box [IES files](#) available.
- spring clips for use with Plate to mount to 2–4" dia. hole in drywall



Patent [www.juniper-design.com/patents/](http://www.juniper-design.com/patents/)

JUNIPER-DESIGN.COM

# SYSTEM SPECIFICATIONS

## SPOTLIGHTS MONOPOINT

### 60 MM, STANDARD STEM

- CRI 95-98
- R9 94-99
- Rf 96-98
- Rg 99-102
- 85-90 LM/W delivered efficacy
- Standard accent luminaire powered via 24VDC low voltage power supply
- Hardware included for mounting: #8 toggle bolt for direct mount to surface
- Field-replaceable lenses and accessories available
- Fully 360 degree/0-90 degree adjustable

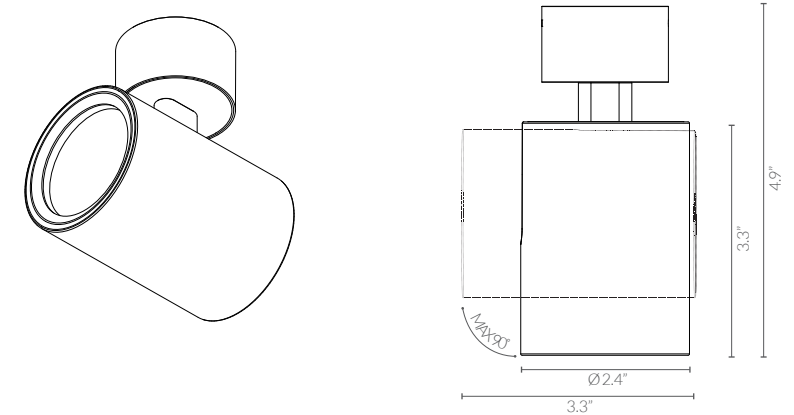

#### MONOPOINT 1000LM | 3000K

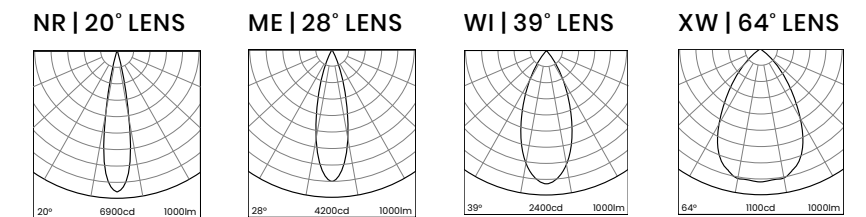

#### MONOPOINT 1500LM | 3000K

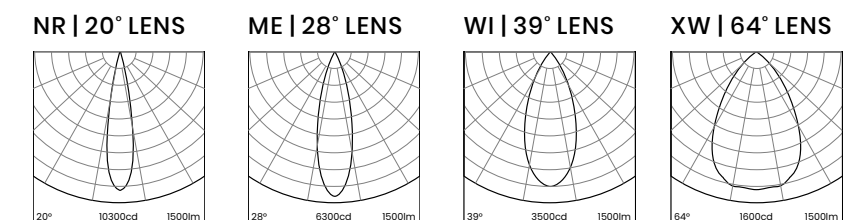

Patent [www.juniper-design.com/patents/](http://www.juniper-design.com/patents/)

SALES@JUNIPER-DESIGN.COM



# SYSTEM SPECIFICATIONS

## SPOTLIGHTS MONOPOINT

### 45 MM, LONG STEM

#### SPECIFICATION BUILDER

JPR-MLTV-MPT1-	<b>45</b>	<b>050</b>	<b>A</b>				<b>N</b>	
	1	2	3	4	5	6	7	8

MODEL	1. SIZE	2. OUTPUT	3. DIMMING	4. STEM
JPR-MLTV-MPT1-	45 45 MM DIAMETER	050 500LM   5.1W	A 1%	0006 6" 0012 12" 0018 18" 0024 24" CUXX CUSTOM Maximum length 24"
	5. CCT	6. BEAM SPREAD	7. ACCESSORY SLOT	8. FINISH
	27 2700K 30 3000K 35 3500K 40 4000K	NR NARROW (22) ME MEDIUM (29) WI WIDE (38) XW EXTRA WIDE (65) See <a href="#">lens kits</a> for additional field replaceable lenses	N NONE (SPACER RING) Spacer ring comes standard. See <a href="#">optical accessory kits</a> for field replaceable accessories: H HEX LOUVER S SOFTENING LENS T SNOOT	30 MATTE PURE WHITE 32 MATTE BLACK 33 SATIN ALUMINUM Stock finishes shown. See <a href="#">Finishes</a> for additional options.

ITEM		PART NUMBER
SINGLE PLATE		JPR-MLTV-MPP1-01-XX
DOUBLE PLATE		JPR-MLTV-MPP1-02-XX
TRIPLE PLATE		JPR-MLTV-MPP1-03-XX

Plate includes:

- cross bar for mounting to 4" junction box
- spring clips for use with Plate to mount to 2–4" dia. hole in drywall

For detailed photometrics, see [Photometrics Guide](#).

[IES files](#) available.



Patent [www.juniper-design.com/patents/](http://www.juniper-design.com/patents/)

JUNIPER-DESIGN.COM

# SYSTEM SPECIFICATIONS

## SPOTLIGHTS MONOPOINT

### 45 MM, LONG STEM

- CRI 95-98
- R9 94-99
- Rf 96-98
- Rg 99-102
- 85-90 LM/W delivered efficacy
- Standard accent luminaire powered via 24VDC low voltage power supply
- Hardware included for mounting: #8 toggle bolt for direct mount to surface
- Field-replaceable lenses and accessories available
- Fully 360 degree/0-90 degree adjustable

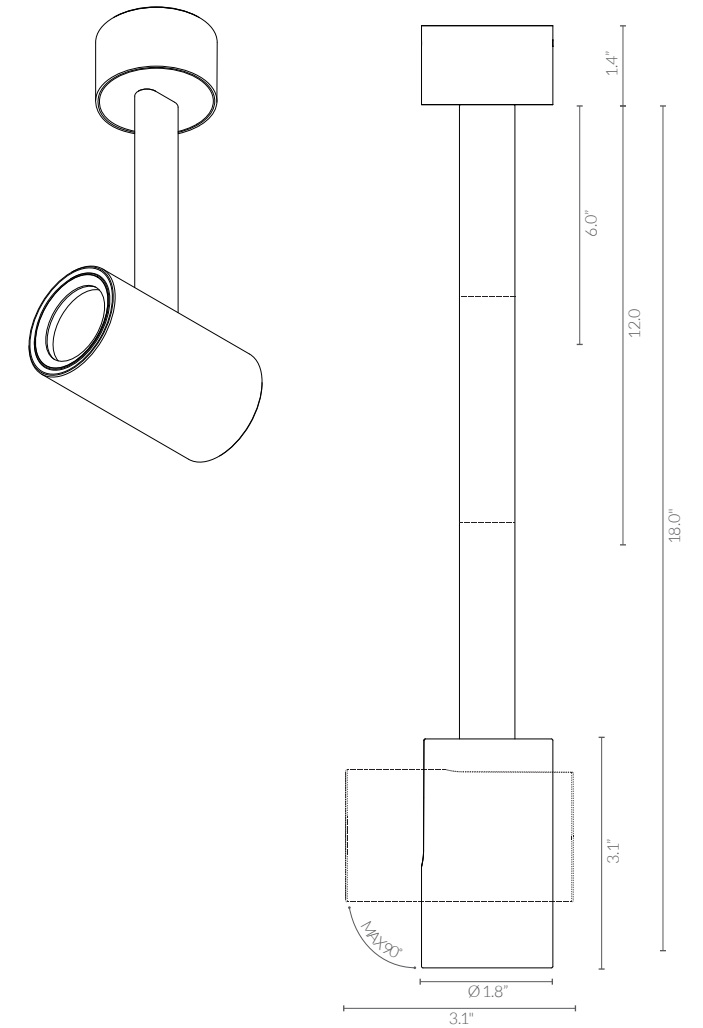

#### MONOPOINT 500LM | 3000K

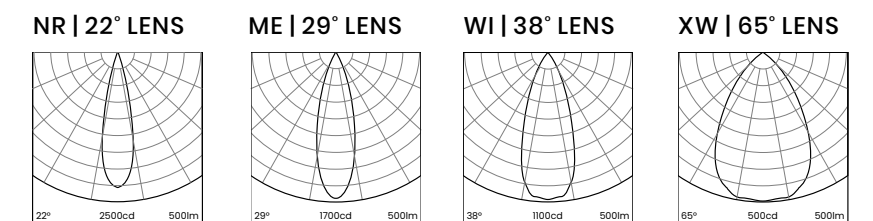

Patent [www.juniper-design.com/patents/](http://www.juniper-design.com/patents/)

SALES@JUNIPER-DESIGN.COM



Updated: 07/12/2023

Updated: 07/12/2023

# SYSTEM SPECIFICATIONS

## SPOTLIGHTS MONOPOINT

### 60 MM, LONG STEM

#### SPECIFICATION BUILDER

JPR-MLTV-MPT1- **60** **A** **N**

1 2 3 4 5 6 7 8

MODEL	1. SIZE	2. OUTPUT	3. DIMMING	4. STEM
JPR-MLTV-MPT1-	<b>60</b> 60 MM DIAMETER	<b>100</b> 1000LM/ 10.9W <b>150</b> 1500LM/ 17.1W	<b>A</b> 1%	<b>0006</b> 6" <b>0012</b> 12" <b>0018</b> 18" <b>0024</b> 24" <b>CUXX</b> CUSTOM  Maximum length 24"
	5. CCT	6. BEAM SPREAD	7. ACCESSORY SLOT	8. FINISH
	<b>27</b> 2700K <b>30</b> 3000K <b>35</b> 3500K <b>40</b> 4000K	<b>NR</b> NARROW (20) <b>ME</b> MEDIUM (28) <b>WI</b> WIDE (39) <b>XW</b> EXTRA WIDE (64)  See <a href="#">lens kits</a> for additional field replaceable lenses	<b>N</b> NONE (SPACER RING)  Spacer ring comes standard. See <a href="#">optical accessory kits</a> for field replaceable accessories: <b>H</b> HEX LOUVER <b>S</b> SOFTENING LENS <b>T</b> SNOOT	<b>30</b> MATTE PURE WHITE <b>32</b> MATTE BLACK <b>33</b> SATIN ALUMINUM  Stock finishes shown. See <a href="#">Finishes</a> for additional options.

ITEM	PART NUMBER
<b>SINGLE PLATE</b> 	JPR-MLTV-MPP1-01-XX
<b>DOUBLE PLATE</b> 	JPR-MLTV-MPP1-02-XX
<b>TRIPLE PLATE</b> 	JPR-MLTV-MPP1-03-XX

Plate includes:

- cross bar for mounting to 4" junction box
- spring clips for use with Plate to mount to 2–4" dia. hole in drywall

For detailed photometrics, see [Photometrics Guide](#).  
[IES files](#) available.  
**DAMP RATED**

# SYSTEM SPECIFICATIONS

## SPOTLIGHTS MONOPOINT

### 60 MM, LONG STEM

- CRI 95-98
- R9 94-99
- Rf 96-98
- Rg 99-102
- 85-90 LM/W delivered efficacy
- Standard accent luminaire powered via 24VDC low voltage power supply
- Hardware included for mounting: #8 toggle bolt for direct mount to surface
- Field-replaceable lenses and accessories available
- Fully 360 degree/0-90 degree adjustable

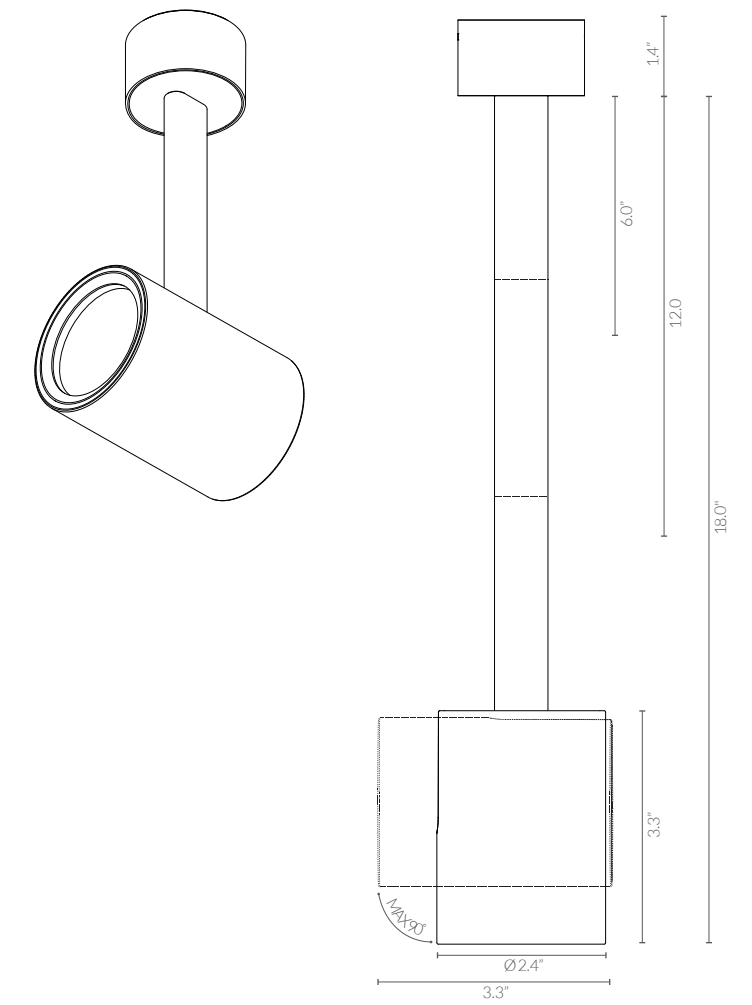

#### MONOPOINT 1000LM | 3000K

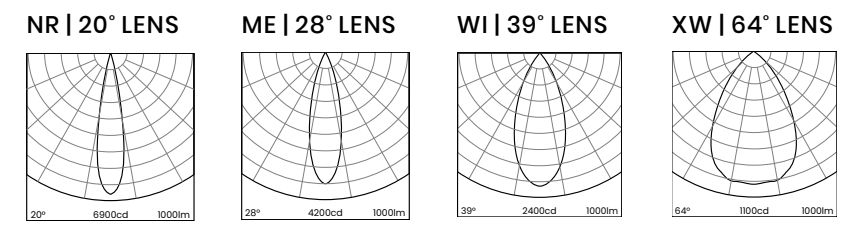

#### MONOPOINT 1500LM | 3000K

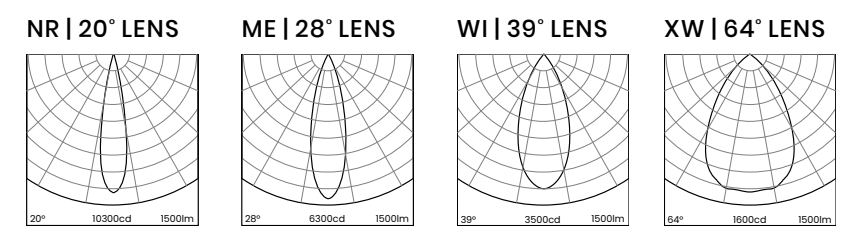

# SYSTEM SPECIFICATIONS

## LENSES AND OPTICAL ACCESSORIES

### 45 MM

ITEM		PART NUMBER
<b>45 MM OPTICAL LENS KIT</b> Narrow 22°, Medium 30°, Wide 38°, and Extra Wide 65° beam angle lenses; comes with a lens removal tool		JPR-MLTV-ACS1-45-L
	<b>45 MM OPTICAL ACCESSORIES KIT</b> Softening glass, hex louver; comes with a lens removal tool	
<b>45 MM SNOOT</b>		JPR-MLTV-ACS1-45-S

# SYSTEM SPECIFICATIONS

## LENSES AND OPTICAL ACCESSORIES

### 45 MM

ITEM		PART NUMBER
<b>45 MM NARROW LENS (22°)</b>		JPR-PMC-0187
<b>45 MM MEDIUM LENS (29°)</b>		JPR-PMC-0188
<b>45 MM WIDE LENS (38°)</b>		JPR-PMC-0189
<b>45 MM EXTRA WIDE LENS (65°)</b>		JPR-PMC-0190
<b>45 MM SOFTENING GLASS</b>		JPR-MLTV-ACS1-45-S
<b>45 MM HEX LOUVER</b>		JPR-MLTV-ACS1-45-H

# SYSTEM SPECIFICATIONS

## LENSES AND OPTICAL ACCESSORIES

### 60 MM

ITEM		PART NUMBER
<b>60 MM OPTICAL LENS KIT</b> Narrow 20°, Medium 28°, Wide 39°, and Extra Wide 64° beam angle lenses; comes with a lens removal tool		JPR-MLTV-ACS1-60-L
<b>60 MM OPTICAL ACCESSORIES KIT</b> Softening glass, hex louver; comes with a lens removal tool		JPR-MLTV-ACS1-60-A
<b>60 MM SNOOT</b>		JPR-MLTV-ACS1-60-S

# SYSTEM SPECIFICATIONS

## LENSES AND OPTICAL ACCESSORIES

### 60 MM

ITEM		PART NUMBER
<b>60 MM NARROW LENS (20°)</b>		JPR-PMC-0192
<b>60 MM MEDIUM LENS (28°)</b>		JPR-PMC-0193
<b>60 MM WIDE LENS (39°)</b>		JPR-PMC-0194
<b>60 MM EXTRA WIDE LENS (64°)</b>		JPR-PMC-0195
<b>60 MM SOFTENING GLASS</b>		JPR-MLTV-ACS1-60-S
<b>60 MM HEX LOUVER</b>		JPR-MLTV-ACS1-60-H

# SYSTEM SPECIFICATIONS

## PHOTOMETRICS DATA

### 45 MM

MULTIVERSE® Spotlights and Monopoints include all 4 lenses. See cone of light data table for approximate footcandles. IES files are available for download on our website.

#### SPOT 500LM | 3000K

NR | 22° LENS

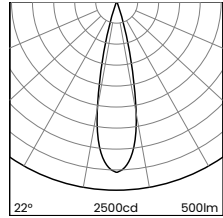

ME | 29° LENS

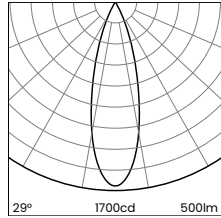

WI | 38° LENS

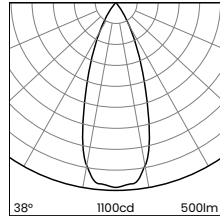

H (F)	FC	DIA (F)
3	274	1.1
6	69	2.3
8	39	3.1
10	25	3.8
12	18	4.6
14	13	5.3
16	10	6.1

H (F)	FC	DIA (F)
3	192	1.5
6	48	3.0
8	27	4.0
10	17	5.0
12	12	6.0
14	9	7.0
16	7	8.0

H (F)	FC	DIA (F)
3	122	2.0
6	31	3.9
8	17	5.2
10	11	6.5
12	8	7.8
14	6	9.1
16	4	10.4

XW | 65° LENS

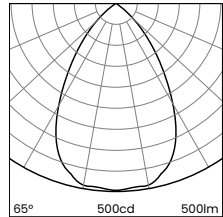

H (F)	FC	DIA (F)
3	55	3.2
6	14	6.4
8	8	8.6
10	5	10.7
12	3	12.9
14	3	15.0
16	2	17.2

# SYSTEM SPECIFICATIONS

## PHOTOMETRICS DATA

### 60 MM

#### SPOT 1000LM | 3000K

NR | 20° LENS

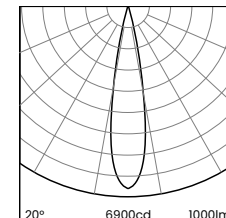

ME | 28° LENS

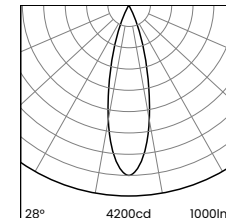

WI | 39° LENS

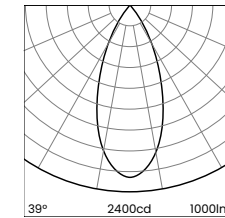

H (F)	FC	DIA (F)
3	763	1.0
6	191	2.1
8	107	2.8
10	69	3.5
12	48	4.2
14	35	4.9
16	27	5.6

H (F)	FC	DIA (F)
3	472	1.5
6	118	2.9
8	66	3.9
10	42	4.8
12	29	5.8
14	22	6.8
16	17	7.7

H (F)	FC	DIA (F)
3	262	2
6	66	4
8	37	5.3
10	24	6.7
12	16	8
14	12	9.3
16	9	10.7

XW | 64° LENS

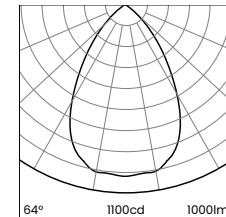

H (F)	FC	DIA (F)
3	119	3.2
6	30	6.4
8	17	8.5
10	11	10.6
12	7	12.7
14	5	14.8
16	4	17

H (F) – height of luminaire above surface in feet  
 FC – footcandles  
 DIA (F) – diameter of lit area

**TYPICAL LIGHT LEVELS**

- OFFICE DESK | **30FC**
- DINING | **7-15FC**
- KITCHEN COUNTER | **30FC**

H (F) – height of luminaire above surface in feet  
 FC – footcandles  
 DIA (F) – diameter of lit area.

**TYPICAL LIGHT LEVELS**

- OFFICE DESK | **30FC**
- DINING | **7-15FC**
- KITCHEN COUNTER | **30FC**



# SYSTEM SPECIFICATIONS

## PHOTOMETRICS DATA

### 60 MM

#### SPOT 1500LM

21° LENS

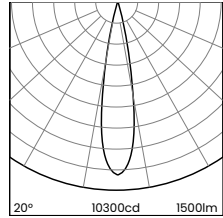

28° LENS

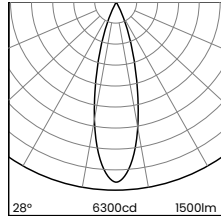

39° LENS

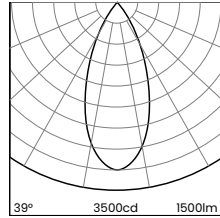

H (F)	FC	DIA (F)
3	1144	1
6	286	2.1
8	161	2.8
10	103	3.5
12	71	4.2
14	53	4.9
16	40	5.6

H (F)	FC	DIA (F)
3	696	1.5
6	174	2.9
8	98	3.9
10	63	4.8
12	43	5.8
14	32	6.8
16	24	7.7

H (F)	FC	DIA (F)
3	393	2
6	98	4
8	55	5.3
10	35	6.7
12	25	8
14	18	9.3
16	14	10.7

64° LENS

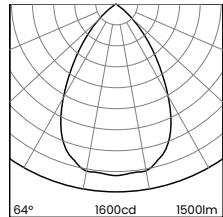

H (F)	FC	DIA (F)
3	178	3.2
6	45	6.4
8	25	8.5
10	16	10.6
12	11	12.7
14	8	14.8
16	6	17

**H (F)** – height of luminaire above surface in feet  
**FC** – footcandles  
**DIA (F)** – diameter of lit area

**TYPICAL LIGHT LEVELS**

- OFFICE DESK | **30FC**
- DINING | **7-15FC**
- KITCHEN COUNTER | **30FC**

# SYSTEM SPECIFICATIONS

## PHOTOMETRICS DATA

### TM-30 REPORTS | COLOR QUALITY

#### SPOT 500LM

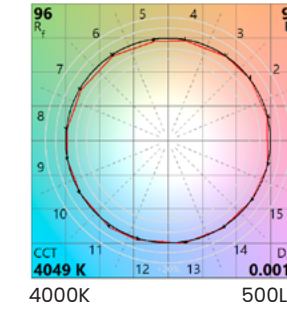
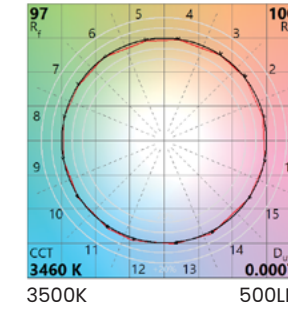
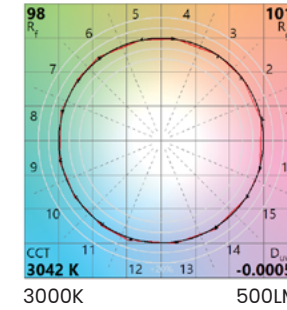
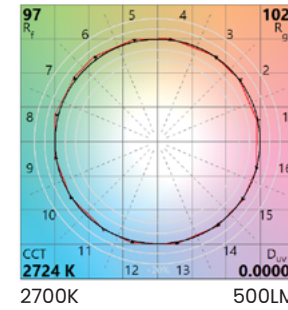

#### SPOT 1000LM / 1500LM

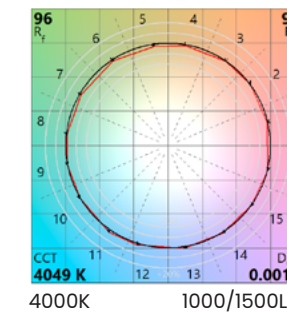
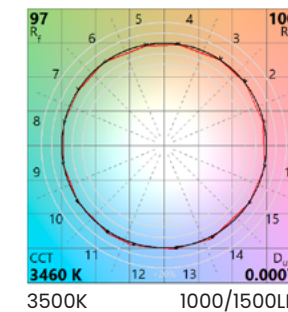
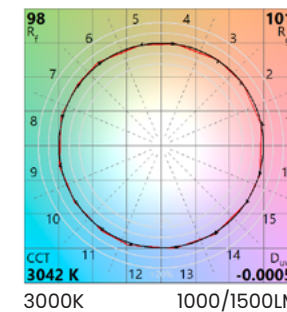
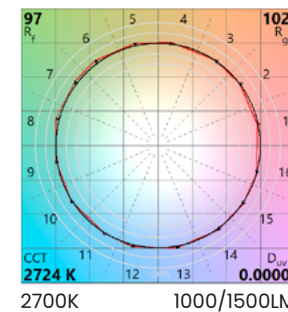

# SYSTEM SPECIFICATIONS

## POWER SUPPLY

- The MULTIVERSE® System power supplies are 120–277V AC input, forward-phase, reverse-phase, and 0–10V dimming to 1% in one package
- UL Listed power supplies are available for remote applications
- Use chart to determine the best wattage for the required layout and run length
- Two circuits are available – to maximize power and/or for separate circuit control, two power supplies are required

ITEM	WATTAGE	INPUT VOLTAGE	DIMMING	PART NUMBER
<b>POWER SUPPLY</b>  24VDC, Triac/ELV/0–10V 1% Dimming, Remote, UL Listed	30W	120–277V AC	Forward-phase, Reverse-phase, 0–10V	PWR-0127
	60W	120–277V AC	Forward-phase, Reverse-phase, 0–10V	PWR-0128
96W				PWR-0129

# SYSTEM SPECIFICATIONS

## SYSTEM AND DRIVER MATRIX

NOMINAL DRIVER WATTAGE	LENGTH OF POWER FEED + RIBBON (FT)	500LM SPOTLIGHT (5.1W)	1000LM SPOTLIGHT (10.9W)	1500LM SPOTLIGHT (17.1W)
30	15	5	2	1
	75	5	2	1
	150	5	2	1
60	15	9	4	2
	75	9	4	2
	150	8	3	2
96	15	15	7	4
	75	13	7	4
	150	8	3	2

Numbers are for one 14 AWG circuit only – there are two circuits per ribbon.  
 Length must include distance between power supply and the ribbon, ≥14 AWG cabling assumed.



# SYSTEM SPECIFICATIONS FINISHES

The MULTIVERSE® System is available in a range of finishes including powder coating, metal plating, and a highly durable heat-cured urethane lacquer applied in our own state-of-the-art finishing department at our Southington Factory.

Custom system finishes are available on request. Lot charges apply.

For all finishes except primer, all ribbon, connectors, and luminaires will have a matching finish.

Primer is available on ribbon and ribbon connector components only. It is intended to be field painted with quality latex acrylic paints to match existing ceiling or wall finishes. Masking of conductors is required with provided masking.



Matte Black **32**



Matte Pure White (RAL 9016) **30**



Primer **31** — Ribbon and Connectors only



Satin Aluminum **33**



Polished Aluminum **37**



Satin Brass **36**

## Custom CU



# LAYOUT GUIDE PLAN

Ribbon segments come in stock sizes — to calculate overall lengths, combine segment dimensions with all connector components. Connector dimensions are available on the Spec Sheets.

Connect long runs with inline connector. All runs must be terminated with an End Cap. Connectors allow for pass through of circuit; ends can be isolated by installing the provided Isolating Tape to the track ends. See [Spec Sheets](#).

A minimum of two mounting clips are provided with each ribbon segment, which is adequate for typical use when placed within 18" apart from each other. Additional mounting clips can be added to support the ribbon where needed in special cases.

## FIELD CUTTING

The ribbon segments may be cut to length. Field cutting should be done with a sharp saw — high-tooth-count miter saw recommended. The field cutting process is covered in detail in the installation guide.

## HOW TO LAY OUT THE MULTIVERSE® SYSTEM

1. Determine remote power feed locations and select [power feed](#) type.
2. Select [ribbon segments](#) and [connectors](#) necessary for desired layout.
3. Select accent [luminaires](#).
4. Determine wattage and select power supplies — use the [Power Supply](#) section for reference.



- |                                   |                           |                                    |
|-----------------------------------|---------------------------|------------------------------------|
| <b>1</b> END FEED J-BOX MOUNTED   | <b>4</b> 90 DEGREE CORNER | <b>7</b> INLINE                    |
| <b>2</b> END FEED SURFACE MOUNTED | <b>5</b> 4 WAY            | <b>8</b> INLINE FEED J-BOX MOUNTED |
| <b>3</b> CONDUIT FEED             | <b>6</b> 3 WAY            |                                    |



# LAYOUT GUIDE MINIMUM DIMENSIONS

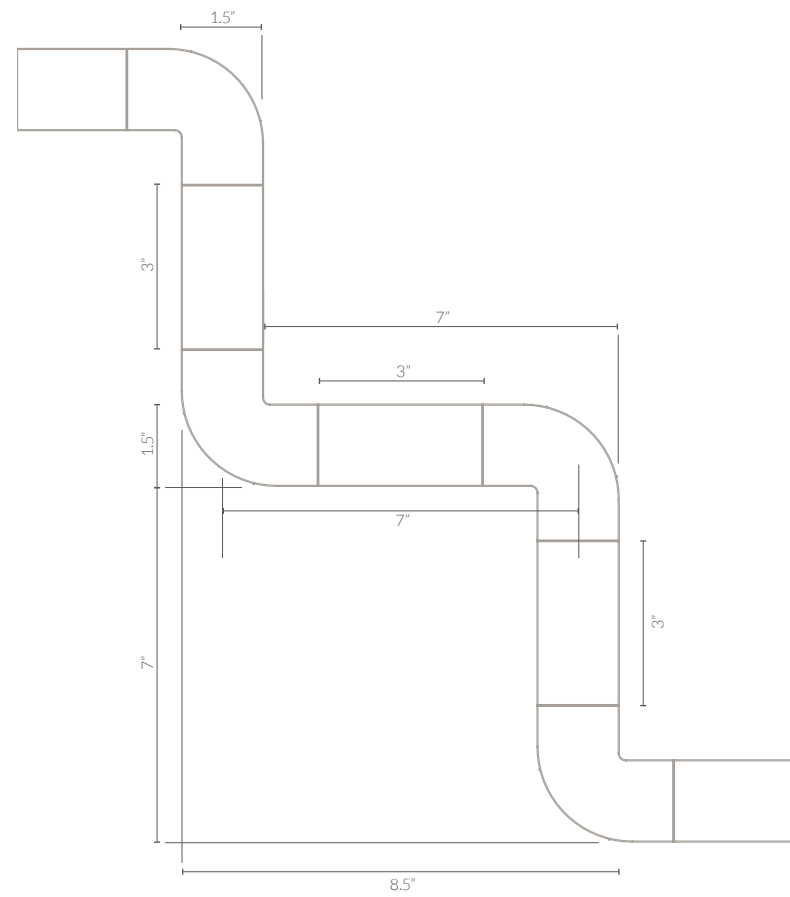
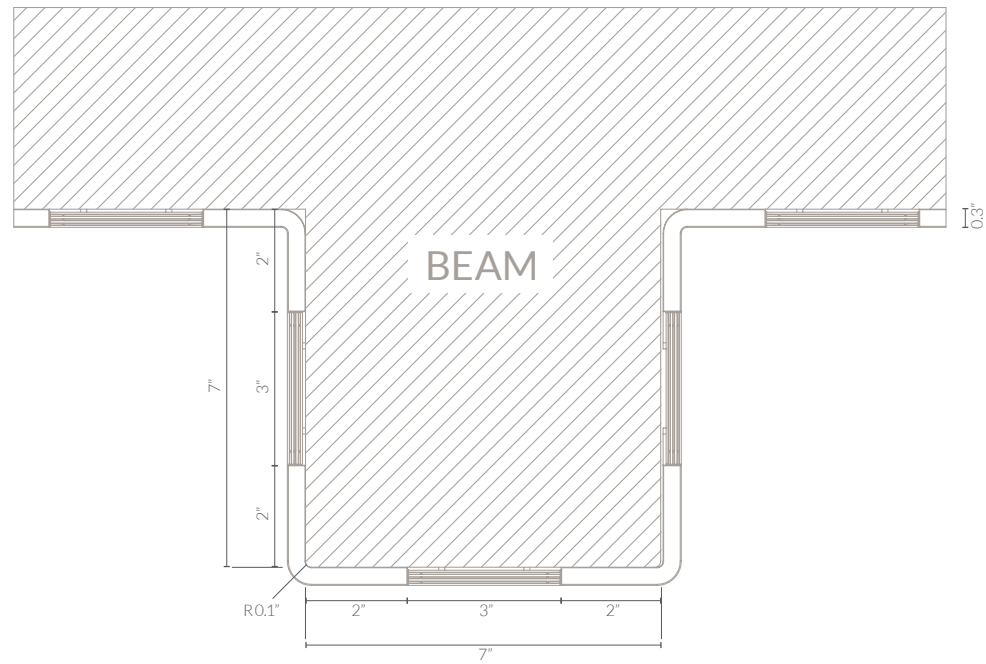

Updated: 07/12/2023



Updated: 07/12/2023